



Tansley review no. 134

Coevolution of roots and mycorrhizas of land plants

Author for correspondence:
Mark C. Brundrett
Fax: +1 618 94803641
Email: mbrundrett@kpbg.wa.gov.au
brundrett@bigpond.com

Received: 3 December 2001
Accepted: 4 January 2002

Mark C. Brundrett

Soil Science and Plant Nutrition, Faculty of Natural & Agricultural Sciences, The University of Western Australia, Nedlands WA 6097, Australia; Postal address: Kings Park and Botanic Garden, Botanic Gardens & Parks Authority, West Perth, 6005, Western Australia

Contents

Summary	275	V. Evolution of Roots	288
I. Introduction	276	VI. The Root as a Habitat for Fungi	290
II. Mycorrhizal Fungi	276	VII. Mycorrhizal Evolution Trends	295
III. The Dawn of Mycorrhizas	279	Acknowledgements	298
IV. Mycorrhizal Associations of Living and Extinct Plants	282	References	298

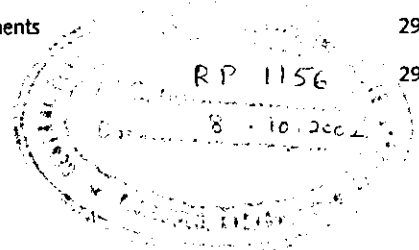

Key words: mycorrhizas, fungi, land plants, evolution, phylogeny, roots, morphology.

Summary

Here, the coevolution of mycorrhizal fungi and roots is assessed in the light of evidence now available, from palaeobotanical and morphological studies and the analysis of DNA-based phylogenies. The first bryophyte-like land plants, in the early Devonian (400 million years ago), had endophytic associations resembling vesicular-arbuscular mycorrhizas (VAM) even before roots evolved. Mycorrhizal evolution would have progressed from endophytic hyphae towards balanced associations where partners were interdependent due to the exchange of limiting energy and nutrient resources. Most mycorrhizas are mutualistic, but in some cases the trend for increasing plant control of fungi culminates in the exploitative mycorrhizas of achlorophyllous, mycoheterotrophic plants. Ectomycorrhizal, ericoid and orchid mycorrhizas, as well as nonmycorrhizal roots, evolved during the period of rapid angiosperm radiation in the Cretaceous. It is hypothesised that roots gradually evolved from rhizomes to provide more suitable habitats for mycorrhizal fungi and provide plants with complex branching and leaves with water and nutrients. Selection pressures have caused the morphological divergence of roots with different types of mycorrhizas. Root cortex thickness and exodermis suberization are greatest in obligately mycorrhizal plants, while nonmycorrhizal plants tend to have fine roots, with more roots hairs and relatively advanced chemical defences. Major coevolutionary trends and the relative success of plants with different root types are discussed.

I. Introduction

Mycorrhizas ('fungus-roots') are symbiotic associations between specialised soil fungi and plants. Seven types of mycorrhizas are recognised, but several are very similar (Brundrett, 2002). Vesicular-arbuscular mycorrhizas (VAM, also called arbuscular mycorrhizas), are the most widespread type (see Section IV). Ectomycorrhizas (ECM) occur in certain families of gymnosperms and, dicotyledons and in one monocotyledon genus. The remaining types of mycorrhizas are restricted to specific plant families. Certain angiosperm families have plants with nonmycorrhizal (NM) roots (Brundrett, 1991).

Some terminology used to describe mycorrhizas in this review differs from that used elsewhere. The term *balanced* is used to describe a category of mycorrhizal association where we have good reason to believe that both organisms receive substantial benefits and there is a quantitative relationship between benefits received by both partners, due to simultaneous two-way exchange processes across a common interface. Mycorrhizal associations where fungi do not seem to receive any benefits from plants have been called *epiparasitic*, *myco-heterotrophic*, or *cheating* associations (Furman & Trappe, 1971; Leake, 1994; Taylor & Bruns, 1999). In this review the term *exploitative* associations is used to reflect the nature of the relationship from the fungal perspective. *Balanced* and *exploitative* associations form the mid-point and one end-point of a continuum of plant-fungus interactions that starts with *endophytic* associations. *Endophytic* fungi live in plants without causing symptoms (Wilson, 1993; Saikkonen *et al.*, 1998). A more comprehensive discussion of mycorrhizal definitions and terminology has been submitted (cited here as MC Brundrett, unpublished).

The objectives of this review are to summarise knowledge about mycorrhizal associations across the diversity of plant life from a taxonomic and evolutionary perspective and identify dominant evolutionary trends. First the origin of mycorrhizal fungi and key stages in the evolution of their associations with plants are considered. Root-fungus coevolution is discussed to help provide explanations for why plants evolved mycorrhizas, how roots may have evolved as habitats for fungi, and why their morphology varies between plants with different associations. Finally, factors driving the evolution of mycorrhizal strategies in modern and ancient plants are discussed.

II. Mycorrhizal fungi

There is only limited fossil evidence of Paleozoic fungi (Taylor & Osborn, 1996), but molecular evidence suggests they diverged from other living organisms deep in the Proterozoic (Wang *et al.*, 1999). Thus, it is probable that the first terrestrial fungi colonised land long before plants did. Soil surface microbial communities containing fungi and algae were probably the first terrestrial associations between fungi and photosynthetic organisms (Gehrig *et al.*, 1996; Evans & Johansen, 1999;

Schüßler & Kluge, 2000). Most Paleozoic fossils of fungi resemble oomycetes, chytrids or zygomycetes, protoctistan organisms that are not directly related to any mycorrhizal fungus lineages (Taylor & Taylor, 1997). These fossils provide examples of putative parasitic plant-fungus associations (similar fungi probably were long established parasites of aquatic algae), but evidence of *saprophytism* is rare until much later (Taylor & Osborn, 1996). There is scant fossil evidence of lichens in the Paleozoic (Taylor & Osborn, 1996), except for a Devonian fossil that may be a zygomycete lichen (Taylor *et al.*, 1997).

1. VAM fungi

The VAM fungi of today are placed in the zygomycete order Glomales in the genera *Glomus*, *Acaulospora*, *Scutellospora*, *Gigaspora*, *Paraglomus* and *Archaeospora* (Morton & Redecker, 2001). These fungi are considered to be primitive due to their relatively simple spores, their lack of sexual reproduction and because there are relatively few species of these fungi and they associate with a wide diversity of plants (Morton, 1990). These fungi are incapable of growth without plants. Ribosomal genome diversity within these fungi is consistent with the absence of sexual reproduction and makes it difficult to define species and individuals (Hosny *et al.*, 1999; Pringle *et al.*, 2000). The functional diversity of these fungi is likely to be much greater than is suggested by the number of currently recognised species (Brundrett, 1991; Abbott *et al.*, 1992).

Fossil spores considered to belong to the Glomales are found in the early Paleozoic (Table 1), but these may have been saprophytic, algae-associated, or parasitic. The antiquity of mycorrhizal members of the Glomales is strongly supported by phylogenetic analyses using DNA sequence data from living taxa. Simon *et al.* (1993) estimated that the Glomales were of similar age to land plants, but their study did not include the most primitive members of this group (Redecker *et al.*, 2000b). Since the Glomales are one of the oldest groups of true fungi and a monophyletic sister group to the dikaryomycetes (higher fungi) (Gehrig *et al.*, 1996; Tehler *et al.*, 2000), they must be much older than land plants. The occurrence of VAM fungi with morphology patterns that roughly correspond to modern genera of the Glomales in Triassic roots confirms that mycorrhizal glomalean fungi had evolved by that time (Phipps & Taylor, 1996).

The Glomales consist of a number of ancient lineages that may have diverged before or after these fungi first became mycorrhizal (Redecker *et al.*, 2000b; Schüßler *et al.*, 2001). However, they form a single coherent lineage when differences within them are contrasted with the extent of separation from other living fungi.

It is inevitable that early land plants were colonised by saprophytic, parasitic, or soil-surface fungi (Section III). Saprophytic fungi are the most likely candidates, as they would have the enzymes required to penetrate plant cell walls

Table 1 The early history of fungi in the Glomales thought to form vesicular-arbuscular mycorrhizas based on fossil evidence* and DNA sequence data

Period	Evidence
Proterozoic 1500 Myr	Suggested age of divergence of fungi from other life (Wang <i>et al.</i> , 1999)
Proterozoic? > 570 Myr	DNA sequences show Glomalean fungi are monophyletic and may be the sister group to the higher fungi (Schüßler <i>et al.</i> , 2001; Tehler <i>et al.</i> , 2000)
Cambrian? > 500 Myr	Fungi would have colonised land long before plants, but left scant early fossil evidence (Taylor & Osborn, 1996)
400–500 Myr	Approximate origin of Glomales according to a DNA molecular clock estimates (Berbee & Taylor, 1993; Simon <i>et al.</i> , 1993)
Ordovician (460 Myr)*	Earliest fossil spores identified as glomalean (Redecker <i>et al.</i> , 2000a)
Devonian (400 Myr) to Present*	Many reports of fossil spores resembling the Glomales (Pirozynski & Dalpé, 1989)
Unknown to Present	<i>Geosiphon</i> – a soil crust fungus with endosymbiotic cyanobacteria that rRNA sequence data suggests is a primitive glomalean fungus (Schüßler & Kluge, 2000)

All dates are approximate.

(Taylor & Osborne, 1996). However, another possibility is *Geosiphon* – a soil-surface fungus with endosymbiotic cyanobacteria (Schüßler & Kluge, 2000). Phylogenetic studies based on SSU rDNA (18S) sequence data show that *Geosiphon* is a primitive glomalean fungus (Tehler *et al.*, 2000; Schüßler *et al.*, 2001). *Geosiphon* associations occur in swollen hyphae with an endosymbiont interface similar to the arbuscule interface of VAM (Schüßler & Kluge, 2000). Thus, some characteristics of the first mycorrhizal fungi required for effective association with plants may have evolved during earlier associations with cyanobacteria. A third possibility is that the Glomales descended from endophytes of the algal precursors of land plants, but no similar associations of marine algae are known today (Kohlmeyer & Kohlmeyer, 1979). The Glomales are not closely related to any of the parasitic fungi found in early plant fossils (oomycetes and chytrids – Taylor & Osborn, 1996; Taylor & Taylor, 1997), and thus are unlikely to have a parasitic ancestor. Other types of mycorrhizal fungi are much younger than the Glomales (Tehler *et al.*, 2000).

2. ECM fungi

ECM fungi include at least 6000 species, primarily of basidiomycetes with some ascomycetes and zygomycetes, but their diversity is poorly known in tropical and southern regions (Molina *et al.*, 1992; Castellano & Bougher, 1994). Recognition of fungi by mycorrhizal morphology (Agerer, 1995; Massicotte *et al.*, 1999), lipid profiles (Olsson, 1999), or DNA-based methods (Gardes & Bruns, 1996; Jonsson *et al.*, 1999) have shown that ECM roots often contain fungi that cannot be linked to epigeous fruiting bodies. These cryptic fungi may produce hypogeous sequestrate (truffle-like) (Bougher & Lebel, 2001), or resupinate (crusting) fruiting bodies (Erland & Taylor, 1999), or they may be sterile like the widespread fungus *Cenococcum geophilium* (LoBuglio *et al.*, 1996; Shinohara *et al.*, 1999), or fruit very infrequently.

Phylogenetic studies using DNA-sequence data suggest that the agarics are derived from wood rotting fungi (e.g. polypores), and two of the largest ECM groups, the Boletales and Russulales, are sister to most other agarics (Moncalvo *et al.*, 2000). The capacity to form ECM may have been a key defining step in the evolution of the agarics. Fossil evidence for larger fungi is very limited (Taylor & Taylor, 1997). It is likely that a period of rapid diversification of the basidiomycetes occurred in the Cretaceous, as plants with ECM associations became important (Section IV). ECM Basidiomycete taxa like the Cortinariaceae, Boletales, Amanitaceae and Russulaceae probably arose at this time. The rapid diversification of these fungi continues to this day, driven by increasing host and habitat specificity. Further evidence that ECM fungi evolved from saprophytic fungi, is provided by the production of enzymes that can digest plant cell walls, but these generally occur at much lower levels than in saprophytic fungi (Bending & Read, 1997; Kohzu *et al.*, 1999).

Ectomycorrhizal basidiomycetes are polyphyletic and interspersed with their saprophytic relatives, with multiple lineages that have gained or lost the capacity to form mycorrhizas (Hibbert *et al.*, 2000; Moncalvo *et al.*, 2000). However, most ECM fungi belong to large basidiomycete families like the Amanitaceae, Boletaceae and Russulaceae whose members are highly consistent in their relationships with plants. Phylogenetic studies have shown that fungi with agaricoid, gastroid and resupinate fruit bodies, classified in different families by morphological schemes, can be closely related (Kretzer & Bruns, 1999). Ascomycetes which form ECM have four or more separate origins (LoBuglio *et al.*, 1996). The polyphyletic origins of ECM fungi (Hibbert *et al.*, 2000; Moncalvo *et al.*, 2000) suggests there should be considerable functional diversity in these fungi. For example, some primarily utilise inorganic N, but most use organic N sources (Turnbull *et al.*, 1995; Gebauer & Taylor, 1999; Högborg *et al.*, 1999). Other ECM fungi are capable of weathering rock (Paris *et al.*, 1995;

Landerweert *et al.*, 2001), or acquiring nutrients from other soil organisms (Ponge, 1991; Lindahl *et al.*, 1999).

ECM fungi associate with either a narrow, intermediate, or broad range of host plants, and intermediate host range fungi appear to be most common (Molina *et al.*, 1992; Horton & Bruns, 1998). The fact that certain genera of fungi associate with particular families of trees is strong evidence for coevolution (Molina *et al.*, 1992; Bougher *et al.*, 1994; Kretzer *et al.*, 1996; Wu *et al.*, 2000). Some geographic regions have many hypogeous ECM fungi that have coevolved with mycophagous animals (Cázares *et al.*, 1999; Bougher & Lebel, 2001). Some ECM fungi can be grown in axenic culture but some can not. These fungi are not known to occur in nature in the absence of host their plants.

3. Other mycorrhizal fungi

Mycorrhizal fungi that associate with members of the Ericaceae and Epacridaceae include several groups of ascomycetes which generally do not form mycorrhizas with other vascular plants (Smith & Read, 1997). Studies of DNA sequences of fungi from these plants in Australia, Europe and North America have revealed two or more distantly related groups of fungi involved in ericoid mycorrhizas (McLean *et al.*, 1999; Monreal *et al.*, 1999; Sharples *et al.*, 2000). *Hymenoscyphus*-like fungi associate with the Ericales and bryophytes throughout the world, but other taxa are more restricted to specific geographic regions (Chambers *et al.*, 1999; Read *et al.*, 2000). It is not certain whether ericoid mycorrhizal fungi exist primarily as soil saprophytes, or as mycorrhizal associates of plants. If they are less dependant on plants than VAM or ECM fungi, their capacity to form mycorrhizal associations would not be a factor driving their evolution (see below). Ericoid mycorrhizal associations are considered to detoxify highly acidic soils and to acquire organic nutrients (Smith & Read, 1997). Substantial nutritional benefits have been shown in some experiments, but not in others (Bell & Pate, 1996; Jansa & Vosátka, 2000) and these may be facultative associations (see VI.4).

Members of the Ericales with monotropoid or arbutoid mycorrhizas (ECM-like associations) generally have much higher host-fungus specificity than other ECM associations. For example, several closely related species of the hypogeous ECM genus *Rhizopogon* are the only known associates for *Pterospora* and *Sarcodes* in western North America (Cullings *et al.*, 1996; Taylor & Bruns, 1999; Bruns & Read, 2000; Kretzer *et al.*, 2000).

Orchids have mycorrhizal associations with soil fungi believed to be essential for seed germination and to assist the growth of adult plants (Rasmussen, 1995; Currah *et al.*, 1997). Most orchids have fairly specific fungal associates that vary between host species and habitat (Warcup, 1981; Ramsay *et al.*, 1987; Currah *et al.*, 1997; Sen *et al.*, 1999). Most of these fungi are assigned to the anamorphic form genus *Rhizoctonia* (Currah *et al.*, 1997). It is not clear if orchid fungi from different regions are more closely related to each other, or

to saprophytic or parasitic groups of *Rhizoctonia* species. For example, Pope & Carter (2001) discovered that pathogenic isolates from South Africa were the closest known relatives of *Rhizoctonia solani* isolates from an Australian orchid (*Pterostylis* sp.). It seems most likely that orchid fungi are a disparate group with many separate origins and the recruitment of new fungal lineages by orchids continues today (see below). The benefits provided by orchids to their mycorrhizal fungi, if any, are not clear, as these fungi seem to grow as well without their hosts as they do with them.

Saprophytic (myco-heterotrophic) orchids without chlorophyll have fully exploitative mycorrhizal associations that supply both the energy and nutrient requirements of the host (Leake, 1994). Many of these plants associate with fungi that are not related to the mycorrhizal fungi of green orchids, including ECM associates of trees, wood-rotting and parasitic fungi (Table 2). These associations have a high degree of host-fungus specificity and species of *Corallorhiza*, *Gastrodia* and *Galeola* may only associate with a single fungal genus (Table 2).

4. What is a mycorrhizal fungus?

Categories of mycorrhizal associations and fungi in Table 3 are defined by differences in evolution or inferred from our knowledge of the physiology and ecology of the organisms. The four types of mycorrhizal fungi in Table 3 are either: of similar age to land plants; of similar age to the angiosperms; recently recruited; or not coevolving with plants. The Glomales are unique as the only monophyletic mycorrhizal fungus lineage that has coevolved with land plants throughout their history. Other mycorrhizal fungi have polyphyletic lineages that represent parallel or convergent evolution (Table 3). There is a strong relationship between the age of plant-fungus associations and the degree of dependence of mycorrhizal fungi on their hosts, as all VAM and some ECM fungi are incapable of independent growth (in nature or axenic culture), while other categories of mycorrhizal fungi can grow without host plants.

Mycorrhizal fungi with a high degree of host specificity are likely to track the evolution of their hosts closely, while others are likely to evolve much more independently. In particular, ECM fungi seem to be evolving faster than their hosts, resulting in a great diversity of fungal taxa and ECM root structures. The greatest uncertainty concerns fungi forming ericoid and orchid associations capable of growth without plants, which probably include recently recruited lineages of soil fungi. If the primary role of these category 3 fungi is as saprophytes, or parasites, their evolution will not be influenced by plants. There are likely to be some exceptions to the generalisations in Table 3. The lichen fungi are also polyphyletic, with five separate known origins from basidiomycete or ascomycete fungi (Gargas *et al.*, 1995).

In conclusion, four types of mycorrhizal fungi with major differences in their biology and evolution can be recognised. Mycorrhizal associations also have major differences in,

Table 2 Examples of mycorrhizal associations restricted to small groups of angiosperms which are likely to be of recent origin

Hosts	Structure	Fungi	References
Exploitative orchids without chlorophyll (e.g. <i>Corallorhiza</i>)	Hyphal coils in rhizome cells (orchid)	ECM associates of trees (Russulaceae or Telephoraceae)	Furman & Trappe (1971); Leake (1994); Taylor & Bruns (1999)
Exploitative orchids (<i>Galeola</i> , <i>Gastrodia</i> , <i>Erythrorchis</i>)	Hyphal coils in rhizome cells (orchid)	Highly specific associations with wood rotting or parasitic fungi (<i>Armillaria</i> , <i>Armillariella</i>)	Terashita & Chuman (1987); Currah <i>et al.</i> (1997); Umata (1998), (1999)
Orchid (<i>Corybas</i>)	Hyphae and vesicles in roots (mycorrhizal?)	VAM fungi	Hall (1976)
Exploitative monotropoid mycorrhizal plants without chlorophyll (<i>Monotropa</i> , <i>Pterospora</i> , <i>Sarcodes</i>)	ECM, but with hyphal projections into host cells in very complex interface	Highly specific ECM fungi that also associate with trees (<i>Rhizopogon</i> sp.)	Björkman (1960); Castellano & Trappe (1985); Bruns & Read (2000); Kretzer <i>et al.</i> (2000)
Mycro-heterotrophic plants without chlorophyll in families Burmanniaceae, Gentianaceae, Triuridaceae, etc. (e.g. <i>Triuris</i> , <i>Thismia</i> , <i>Voyria</i>)	VAM but with unusual patterns of hyphal growth and often without arbuscules	VAM fungi	McLennan (1958); Leake (1994); Imhof (1998), (1999abc)
Plants considered to have partially exploitative VAM (e.g. some Gentianaceae)	Require a companion plant for mycorrhiza formation	VAM fungi	See text
Thysanotus (Anthericaceae) ECM plants in typically NM families <i>Kobresia</i> : Cyperaceae, <i>Polygonum</i> : Polygonaceae, <i>Neea</i> , <i>Pisonia</i> : Nyctaginaceae	Hyphae in subepidermal cavity ECM with mantle and Hartig net	Unknown fungi ECM fungi	McGee (1988a); Brundrett (1999) Fontana (1963); Massicotte <i>et al.</i> (1998); Ashford & Allaway (1982)
Isolated examples of ECM plants in VAM families: (e.g. <i>Dryas</i> : Rosaceae) Superficial ECM associations of some herbaceous plants from VAM families in Australia (e.g. Asteraceae, Goodeniaceae)	ECM with mantle and Hartig net ECM-like, but without mantle and with a thin Hartig net. Function uncertain	ECM fungi Ascomycetes that may not form ECM with other plants	Melville <i>et al.</i> (1987) Warcup (1980); Kope & Warcup (1986); McGee (1988b)
Ericales in Hawaii	Ericoid mycorrhizas and VAM with arbuscules	Ericoid and VAM fungi	Koske <i>et al.</i> (1990)
Sedges and rushes (Cyperaceae, Restionaceae, etc.)	Occasional VAM in roots of some species but not others, role uncertain	VAM fungi	Meney <i>et al.</i> (1993); Lovera & Cuenca (1996); Miller <i>et al.</i> (1999)

See Table 3 for abbreviations.

nutrient transfer processes, host-fungus specificity, etc. (Table 3). Consequently, knowledge obtained from one category of fungus or plant cannot be indiscriminately applied to others. Mycorrhizal fungi differ from other fungi primarily because they are dual soil-plant inhabitants that would have evolved to become efficient at growth and nutrient uptake in both soil and plants. Conversely, endophytes and pathogens are primarily plant inhabitants without efficient

means of acquiring nutrients from soils, and have evolved to become more efficient at invading, and living within, plants.

III. The dawn of mycorrhizas

A sequence of events for the origin of mycorrhizal associations is proposed here to stimulate debate. We are unlikely to ever fully understand these evolutionary processes, due to limited

Table 3 Evolutionary and functional categories of plant–fungus associations

	VAM	ECM	Ericoid	Orchid	Exploited	Pathogen	Endophyte
Association:							
Plant provides a key habitat for fungus	+	+–	–?	?	–?	+	+
Fungus efficient at mineral nutrient acquisition from soil	+	+	+	+	– or +	–	–
Interface hyphae highly specialised	+	+	–	–	+ or –	+	–
Plant–fungus coevolution	+	+	?	–?	–	–	–
Estimated age of association (Myr) (Table 3)	> 400	> 100	< 100	+–100	recent	> 1000	> 400
Host–fungus specificity	low	medium	medium	high, medium	extremely high	varies	high?
Role:							
Mineral nutrient transfer to plant	+	+	+?	+	+	–	–
Energy transfer to fungus	+	+	+?	– or +?	–	+	+–
Energy transfer to plant	– (+)	– (+)	–	+ or –	+	–	–
Plant:							
Switched to new fungus lineages	–	+	+	+	+	–	–
Recruitment of new plant lineages continues	?	+	–	–	+	+	+
Photosynthesis	+ (–)	+ (–)	+	+ (–)	–	+	+
Obligate requirement for association	+ or ±	+	+?	+ or –	+	–	–
Fungus:							
Multiple lineages of fungi	–	+	+	+	+	+	+
Recruitment of new fungal lineages continues	–	+	+?	+	+	+	+
Obligate (host required for growth)	+	+	?	–	–	+	+ or –?
Capable of independent growth (in axenic culture)	–	+ or –	+	+	+ or –	+ or –	+
Mycorrhizal fungus category (see text)	1	2	2 or 3		1, 2, 3 or 4	not mycorrhizal	

Question marks indicate uncertain roles where further investigation is required, brackets indicate unusual states that sometimes occur.

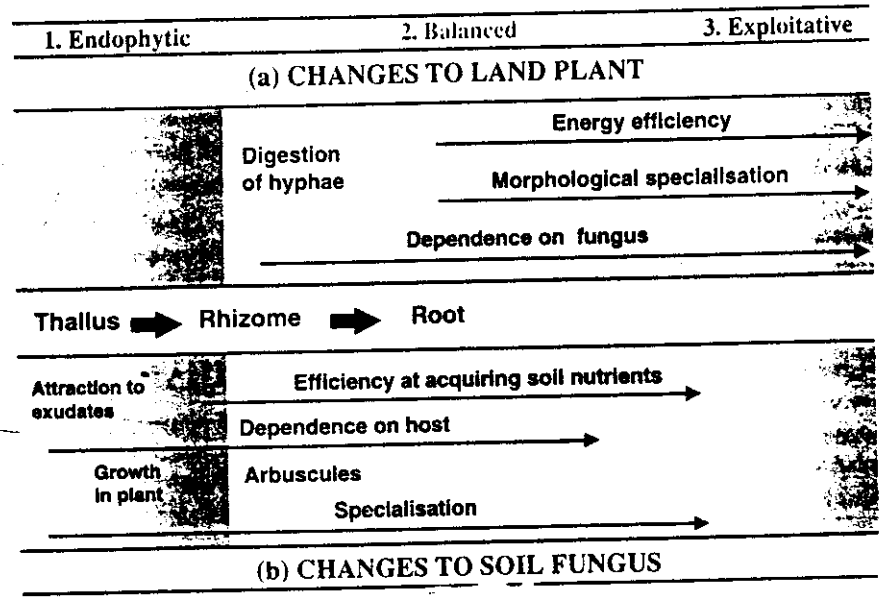

Fig. 1 The hypothetical order of (a) changes to plants (upper half) and (b) fungi (lower half) during three stages in the evolution of vesicular-arbuscular mycorrhizas.

fossil evidence. The proposed stages in mycorrhizal evolution outlined in Fig. 1 follow categories of plant–fungus interaction defined in Section I: endophytic fungi; balanced associations; and exploitative associations. These are stages in evolutionary continua representing increasing levels of commitment and specialisation by plants and fungi.

1. Endophytic associations

Endophytic fungi are ubiquitous in plants (Wilson, 1993; Saikkonen *et al.*, 1998) and are the most likely source of new plant–fungus associations. These begin as casual associations where both the plant and fungus have the capacity to exist

alone. Some endophytes provide benefits, but others are probably detrimental to their hosts (Saikonen *et al.*, 1998). Fungal endophytes benefit from occupying plants by gaining: greater access to exudates; first access to organic substrates after the death of the host; and avoidance of competition, predation and parasitism from other soil organisms. Mycoparasitic soil fungi similar to those that attack modern VAM fungi were present in Paleozoic soils (Hass *et al.*, 1994), probably following them onto land much earlier. Thus, early soil fungi would have faced selection pressure to avoid parasitism, by growth within plant organs. Extant VAM fungi commonly occur within other organisms (Koske, 1984).

Early land plants growing in full sunlight would have had abundant supplies of photosynthetically produced carbon compounds that accumulated as starch and leaked as exudates into the soil. These plants were exposed to an atmosphere with much higher CO₂ concentrations than today (Mora *et al.*, 1996; Raven & Edwards, 2001). The first land plants were structurally very weak (Kenrick & Crane, 1997) and needed to be highly permeable to acquire water and nutrients. Thus these plants would have been highly attractive to soil fungi (as are living bryophytes) (Section IV.1). The first endophytic fungi would have provided little or no benefit to their hosts, but natural selection may have favoured plant-fungus combinations that did. These endophytes may have largely been restricted to intercellular spaces within plant tissues. Palaeozoic plant fossils contain putative parasitic fungi (Taylor & Osborne, 1996), and the first benefits provided by endophytes might have been to protect plants from other more harmful fungi. Antagonistic interactions between parasitic and endophytic fungi seem to be common today and are the main benefit provided by mycorrhizal fungi to plants in some circumstances (Newsham *et al.*, 1995; Cordier *et al.*, 1998).

The first stage of evolution from endophytic to mycorrhizal fungus would be specialisation to become more efficient at absorption of food within plants, eventually resulting in dependence on the host plant as a source of energy (Fig. 1). At the endophytic stage benefits to the plant would be limited, so it is unlikely that plants would face selection pressures to become better habitats for fungi (Fig. 1). Many of the events outlined above would also occur during the evolution of parasitic fungus-plant associations, but these differ in many ways (see Section II.4). Events in the first stage of mycorrhizal evolution are summarised below.

- 1 Fungi attracted by exudates proliferate on the surface of plants.
- 2 Fungi develop mechanisms for penetrating living plants without causing harm to their hosts.
- 3 The space within living plants becomes an important habitat for these endophytes, providing them with shelter from adverse soil conditions, parasitism and predation.
- 4 Fungi become dependant on the host for energy.
- 5 Absorptive hyphae within plants increase their surface area and permeability.

2. Balanced mutualistic associations

Exchange processes are likely to evolve if both partners have commodities they can afford to release in exchange for limiting resources (Section VII). Early land plants would have had abundant carbon compounds that would have accumulated as starch and leaked into the soil as exudates (see above). However, they are likely have been limited by mineral nutrients, because their coarse rhizomes would have been inefficient at acquiring nutrients (Section V). It is likely that the first land plants grew in soils that were no more fertile than is normal today, due to waterlogging and efficient decomposition of organic matter (Pirozynski & Malloch, 1975; Stubblefield & Taylor, 1988; Taylor & Osborn, 1996). Nutrient availability would also have been much lower in the oxidative soils of dry land, relative to the aquatic environments where plants first evolved (Gryndler, 1992).

Fungi, which had occupied soils for much longer than plants, would already have evolved efficient means of foraging for mineral nutrients. Foraging capacities of modern mycorrhizal fungi include dispersing widely through substrates, responding to temporary, localised nutrient sources, competing with other soil organisms and producing enzymes to release organic nutrients (St. John *et al.*, 1983; Harley, 1989; Marschner, 1995; Smith & Read, 1997). Soil fungi probably accumulated greater quantities of mineral nutrients than they required for immediate use as insurance against future shortages. It is possible that the first mycorrhizas were formed by a *Geosiphon*-like fungus with an abundant supply of nitrogen obtained from associated cyanobacteria (Schüßler & Kluge, 2000).

The first exchange processes which probably began in a diffuse interface zone within the plant where certain cells of the endophytic fungus evolved to become more permeable. We would expect the increased permeability of fungal cells to result in increased leakage of their contents. This would be especially true for substances which were not in short supply, as there would be no strong selection pressure for mechanisms to prevent loss. By contrast, there certainly would have been very strong selection pressure for mechanisms that improved the uptake of limiting resources. Evolutionary changes in membrane functions and wall structures by host and fungus would result in the specialised interface typical of modern mycorrhizal associations (Alexander *et al.*, 1989; Smith & Read, 1997).

Mycorrhizal associations typically have synchronised metabolic activity of host and fungus interface cells that increases rapidly for a limited time and then ceases. This limited period of commitment may have evolved as a safety mechanism to limit energy losses when associations do not provide benefits. However, this results in the need for plants to constantly renew organs to continue receiving benefits from mycorrhizas (Section VI). Balanced mycorrhizal associations occur within plant organs that have evolved in part as specialised habitats for fungi by increasing the efficiency of and/or limiting the extent of mycorrhizal associations (see Section VI).

Recognition mechanisms to distinguish beneficial mycorrhizal fungi from harmful pathogens would have arisen early in the evolution of balanced mycorrhizal associations. Research with NM mutants has identified key stages in the colonisation process where recognition of the fungus by the host plant is necessary for mycorrhizal formation to proceed (Bonfante & Perotto, 1995; Harrison, 1999). Fungal recognition of host roots seems to be less precise, as mycorrhizal fungi often attempt to penetrate nonhost roots and other plant organs (Brundrett, 1991).

The digestion or collapse of hyphae is a consistent feature of VAM and orchid associations but its significance is uncertain (Smith & Smith, 1990). This process is considered to be controlled by the host cell, but may be triggered by the fungus (Alexander *et al.*, 1989). This capacity may have first evolved as a defence against pathogenic fungi, although Pozo *et al.* (1998) found different enzymes induced in root cells by VAM fungi and pathogenic fungi. Hyphal digestion is not considered to be important for nutrient transfer in balanced associations (Smith & Smith, 1990), but may be more important in exploitative plants. It is possible that early mycorrhizal associations were based on digestion of fungi before the two-way exchange processes evolved. However, the capacity of plant cells to digest hyphae has another consequence, which is probably more important, in that it allows re-invasion of the same host cells by new hyphae, and extends the life of associations. In present day plants this only occurs in some orchid and exploitative associations within highly reduced organs, but would have allowed the first land plants to make allow more effective use of their coarse rhizomes.

Balanced mycorrhizal associations evolved to become the primary source of mineral nutrients for plants (see Section VI.4). By this stage, the fungus had evolved into a specialised associate with a limited capacity for independent growth, and fully dependent on the host for energy. The most likely sequence of events in the evolution of balanced mycorrhizas from an endophytic fungal association is:

- 1 Hyphal adaptations for efficient absorption of substrates from the plant result in increased leakage of mineral nutrients to the host.
- 2 Plants containing fungi acquire limiting mineral nutrients more efficiently from hyphae within them than by other means.
- 3 Plants evolve recognition mechanisms to distinguish mycorrhizal fungi from pathogens.
- 4 Specialised plant and fungi cells develop an interface zone where exchange occurs.
- 5 Plants begin to digest older fungal structures within cells.
- 6 Fungal hyphae increase their capacity to acquire the soil nutrients that limit plant growth.
- 7 The plant becomes obligately mycorrhizal, requiring the fungus for growth at normal soil fertility levels.
- 8 The fungus becomes fully dependent on the plant as a food source.
- 9 Plants evolve to become more efficient at mycorrhizal formation (Section VI).

3. Exploitative mycorrhizas

A third proposed stage in mycorrhizal evolution involves fine-tuning of the morphology and physiology of plant organs to gain greater control over mycorrhizal fungi. This evolutionary trend can result in myco-heterotrophic plants without chlorophyll that are full dependant on their fungi both for mineral nutrients and energy, while the fungi apparently do not benefit from these associations (Leake, 1994). These plants have no commodities that can be used for exchange with fungi (Section VII). Some plants are considered to have partially exploitative mycorrhizas or only have these associations as young plants (Section IV). The evolution of myco-heterotrophic plants is discussed in Section VII.

4. Conclusions

A hypothetical scheme for mycorrhizal evolution is presented in Fig. 1. In this scheme, the greatest changes initially occur to the fungus, while changes to the plant occur later. This scheme is most relevant to VAM associations where the fungi appear to have remained relatively static throughout much the history of land plants (Section II). Other types of associations started after plants already had many of the capabilities required to form mycorrhizal associations (Section IV).

IV. Mycorrhizal associations of living and extinct plants

The first land plants were thought to be bryophytes, similar to liverworts or hornworts, with a horizontally spreading thallus and separate sporophyte and gametophyte generations (Kenrick & Crane, 1997; Renzaglia *et al.*, 2000). Fossil evidence of these plants first appeared in the Mid Ordovician to Early Silurian periods (476–432 myr old), but earlier spore tetrads that may be from land plants are known (Table 4). The first land plants most likely evolved from freshwater charophycean algae and probably required wet habitats (Kenrick & Crane, 1997). There are no structurally preserved specimens of these plants to show if they were mycorrhizal. These plants had no roots (Section V).

1. Bryophytes

Mosses, the largest living group of bryophytes, are generally not mycorrhizal, but often contain endophytic hyphae of VAM fungi (Rabatin, 1980; Turnau *et al.*, 1999). Liverworts and hornworts have VAM-like associations with glomalean fungi that form arbuscules in their thalli (Table 4). Fine endophytes (glomalean fungi with very narrow hyphae forming VAM with arbuscules) are common in bryophytes, but other VAM fungi, such as *Glomus* species, are also present (Johnson, 1977; Turnau *et al.*, 1999; Schüßler, 2000). Fine endophytes have much narrower hyphae than other VAM fungi and may

Table 4 The mycorrhizal status of major plant lineages, with approximate ages of lineages from fossil evidence and molecular plant phylogenies. The mycorrhizal status of lineages is primarily derived from observation of living descendants with limited fossil evidence

Period	Plant	Mycorrhizas
Ordovician to Silurian (476–432 Myr) Ordovician (476 Myr) to Present	The first bryophyte-like land plants Liverworts and hornworts	Limited fossils without roots, mycorrhizas unknown VAM-like with arbuscules in thallus (Stahl, 1949; Ligrone, 1988; Turnau et al., 1999; Schüßler, 2000)
Silurian (415–425 Myr) to Present	Mosses (the largest living group of bryophytes)	No roots, NM or endophytic glomalean fungi (Rabatin, 1980; Read et al., 2000)
Early Devonian (400 Myr)	<i>Aglaophyton major</i> : an early land plant of uncertain affinities	VAM-like arbuscules in specialised rhizome meristem (Taylor et al., 1995)
Devonian (395 Myr) to Present	Lycopods: <i>Lycopodium</i> , <i>Selaginella</i> , etc.	VAM in sporophyte, underground gametophyte may have exploitative association (see text)
Devonian (395 Myr) to Present	Sphenophytes: <i>Equisetum</i> , etc.	<i>Equisetum</i> facultative VAM or NM (Koske et al., 1985; Currah & van Dyk, 1986; Dhillon, 1993)
Mid Devonian (385 Myr) to Present	Sphenophytes, Lycopods, Pteridophytes plants Pteridophytes (Ferns)	First plants with roots resembling those of modern VAM, some facultative with fine roots and long hairs (see text)
Mid Devonian to Present	Cycads	VAM (Brundrett, 1999)
Triassic (215–235 Myr)	Cycad from Antarctica (<i>Antarcticycas</i> sp.)	Earliest fossil VAM association in roots (Phipps & Taylor, 1996)
Permian (265 Myr) to Present	Ginkgoales: <i>Ginkgo</i> , etc.	Tree with VAM (Bontante-Fasolo & Fontana, 1985)
Triassic (235 Myr) to Present	Southern Hemisphere conifers: Araucariaceae, Podocarpaceae	Trees with VAM (Baylis et al., 1963; McGee et al., 1999)
Early Jurassic (190 Myr) to Present	Northern Hemisphere conifers (except Pinaceae): Cupressaceae, Taxodiaceae, Taxales, etc.	Trees with VAM (Newman & Reddell, 1987; Harley & Harley, 1987; Brundrett et al., 1996; Smith & Smith, 1997)
Early Jurassic (190 Myr) to Present	Gnetales: <i>Ephedra</i> , <i>Gnetum</i> , <i>Welwitschia</i>	<i>Welwitschia</i> – VAM (Jacobson et al., 1993). <i>Gnetum</i> – ϵ CM (Fassi, 1957; St John, 1980)
Early Cretaceous? (~20 Myr) to Present	Conifers in Pinaceae: <i>Larix</i> , <i>Picea</i> , <i>Pinus</i> , <i>Tsuga</i> , etc.	ECM trees with heterorhizic roots (Noelle, 1910; Brundrett et al., 1990c)
Early Cretaceous (120 Myr) to Present	Angiosperms	See Fig. 3
Cretaceous (100 Myr) to Present	Fagales: Betulaceae, Casuarinaceae, Fagaceae, Juglandaceae, Myricaceae, Nothofagaceae	Single lineage of ECM trees or shrubs with heterorhizic roots (some VAM also) (Smith & Read, 1997; Brundrett, 1999)
Cretaceous (100 Myr) to Present	NM families: Proteaceae, Cyperaceae, Restionaceae, etc.	Oldest known fossils of plants likely to have NM roots
Late Cretaceous, Oligocene, or Eocene to present (90–30 Myr)	Caesalpiniaceae, Fabaceae, Mimosaceae, Myrtaceae, Salicaceae, Tiliaceae, etc.	Several separate ECM lineages (Smith & Read, 1997; Alexander, 1989; Fitter & Moyersoen, 1996; Brundrett, 1999)
Cretaceous (100 Myr) to Present	Orchidaceae	Age estimate based on biogeography and phylogenetics (Chase, 2001)
Late Cretaceous (80 Myr)	Ericalean plants	Oldest known fossils (Nixon & Crepet, 1993) likely to have ericoid mycorrhizas (Cullings, 1996)

Additional data on plant lineages and fossil histories are from Stewart and Rothwell (1993), Taylor and Taylor (1993), Kenrick and Crane (1997), Wing and Boucher (1998), Hill et al. (1999), Renzaglia et al., 2000, Barrett & Willis, 2001. All dates are approximate. Abbreviations: VAM, vesicular-arbuscular mycorrhizal; ECM, ectomycorrhizal; NM, non-mycorrhizal.

have specifically evolved to grow within the narrow rhizoids and confined spaces of bryophytes. Fine endophytes also colonise roots of vascular plants in many habitats (e.g. Hall, 1977; Brundrett *et al.*, 1999).

Liverwort rhizoids are also colonised by the fungi of ericoid mycorrhizas in some ecosystems (Duckett & Read, 1995; Chambers *et al.*, 1999; Read *et al.*, 2000). It is not known how common liverwort colonisation by VAM or ericoid mycorrhizal fungi is, or if they provide benefits to the plants. These may be the oldest forms of balanced mycorrhizal association, or endophytic activity by mycorrhizal fungi. Evidence for the former is provided by the presence of arbuscules, the confinement of hyphae to specific tissues and the expression of different hyphal morphologies in different tissues (Ligrone & Lopes, 1989; Turnau *et al.*, 1999). These morphological adaptations by the host are only likely to evolve if associations are beneficial (Section III). Several species of subterranean achlorophyllous bryophytes apparently have exploitative mycorrhizas (Leake, 1994; Read *et al.*, 2000).

2. Primitive plants

The oldest fossil evidence of mycorrhizas is in the rhizomes of early vascular plants, but it is quite likely that these associations started in the thallus of their bryophyte-like precursors. There are VAM-like hyphae, vesicles and arbuscules in fossil rhizomes from the Devonian period onwards and spores from the Ordovician onwards (Tables 1 and 3). These fungal structures show a remarkable resemblance to modern VAM associations (Stubblefield & Taylor, 1988; Taylor & Osborn, 1996).

Taylor *et al.* (1995) and Phipps & Taylor (1996) provide the most detailed studies of mycorrhizas in rhizome fossils. The consistency and intensity of these associations is typical of obligate VAM in living plants (Section VI). The rhizomes of *Aglaophyton major*, an Early Devonian land plant of uncertain affinities, contained arbuscules that were restricted to a specialised cortical zone, with a meristem that apparently extended the zone containing cells occupied by fungi. This meristem probably evolved to increase the capacity of *Aglaophyton* to control mycorrhizal fungi. However, it is not possible conclusively to prove that early VAM-like associations were mycorrhizal (Section II).

Sphenophytes, lycopodophytes and pteridophytes were the first plants with roots, and arose in the Mid Devonian (Table 1). Their surviving descendants include *Lycopodium*, *Selaginella* and *Isoetes*. These plants have a separate gametophyte phase without roots and a sporophyte with roots and leaves (Foster & Gifford, 1974). Schmid & Oberwinkler (1993) found an unusual association in the subterranean gametophyte of a *Lycopodium* species with some characteristics of VAM, but without arbuscules and with very fine coiled hyphae that were digested in cells. Gametophytes of another species of *Lycopodium* are similar, but have arbuscule-like structures in

cells (Duckett & Ligrone, 1992). The hyphae within these gametophytes have similar ultrastructural features to VAM fungi, but are extremely narrow, so are most likely to be a fine endophyte (Read *et al.*, 2000). These gametophytes probably have exploitative VAM (Leake, 1994). Adult *Lycopodium* and *Selaginella* sporophytes have normal VAM associations (Harley & Harley, 1987; Gemma *et al.*, 1992). *Isoetes* often has VAM, even when growing as a submerged aquatic plant (Beck-Nielsen & Madsen, 2001).

Equisetum was in a separate order of vascular plants (sphenophytes), but recent phylogenetic research places them within the ferns (Renzaglia *et al.*, 2000; Pryer *et al.*, 2001). Mycorrhizas are unknown in the photosynthetic gametophytes of *Equisetum*, but their sporophytes often have VAM with arbuscules, or can be devoid of mycorrhizas (Table 4). These probably are facultative associations, as *Equisetum* has fine roots and long root hairs (M. Brundrett, unpublished).

Pteridophytes (ferns) dominated the world from the Silurian to the Paleozoic and remain a major component of many ecosystems to this day (Rothwell, 1996). Most ferns have roots with VAM, but many have relatively fine roots with long root hairs and limited or inconsistent mycorrhizal colonisation (Table 4). These facultative mycorrhizal associations are considered to be a feature of relatively advanced ferns (the Filicales), while more primitive ferns (such as *Ophioglossum*) typically have relatively thick roots which are consistently mycorrhizal (Boullard, 1979; Berch & Kendrick, 1982; Gemma *et al.*, 1992; Unrug & Turnau, 1999; Zhao, 2000). Myco-heterotrophic VAM occur in the subterranean gametophytes of *Ophioglossum* and *Botrychium* (Schmid & Oberwinkler, 1994; Read *et al.*, 2000). Epiphytic and epilithic ferns are less likely to be mycorrhizal than terrestrial ferns that grow in soil (M. Brundrett, unpublished). Associations with coils formed by an unidentified ascomycete occur in the roots of some epiphytic ferns (Schmid *et al.*, 1995). The report of ECM in a fern (Cooper, 1976) should be discounted as the anatomy of the illustrated root closely resembles that of *Fagus* (Brundrett *et al.*, 1990c) and was probably a *Nothofagus* root that became incorporated in the fibrous base of the fern.

The whisk ferns *Psilotum* and *Tmesipteris* have no roots or leaves and resemble early vascular plants (Foster & Gifford, 1974). However, cladistic analysis of combined morphological and molecular data has shown that they are closely related to the primitive ferns *Ophioglossum* and *Botrychium* which also have subterranean gametophytes (Pryer *et al.*, 2001). *Psilotum* gametophytes have coiled, separate hyphae produced by an unidentified fungus in subterranean gametophytes (Peterson *et al.*, 1981; Gemma *et al.*, 1992). This presumably would be an exploitative VAM association, similar to that of *Ophioglossum* and *Botrychium* gametophytes. Adult plants of *Psilotum* are reported to have VAM with arbuscules in their rhizomes (Read *et al.*, 2000). The loss of roots and leaves in the whisk ferns may have evolved because plants are myco-heterotrophic for part of their life cycle.

3. Gymnosperms

Both living and Triassic fossil cycads had VAM in roots (Table 4). The gymnosperm trees that dominated the Earth's forests in the Jurassic and Cretaceous included genera such as *Podocarpus*, *Araucaria*, *Agathis*, *Pyllocladus* and *Ginkgo* with VAM (Table 4). These VAM conifers have remained dominant in some forests of the Southern Hemisphere. Gymnosperms, other than *Gnetum* and members of the Pinaceae, generally have VAM, but there are reports, such as the single ECM root of *Wollemia* observed by McGee *et al.* (1999) and the occasional ECM roots of *Juniperus* (Reinsvold & Reeves, 1986), that require further investigation. No NM or myco-heterotrophic gymnosperms are known.

Members of the Pinaceae have ECM (Table 4) and may have evolved from gymnosperms with VAM, or the Gnetales (Stewart & Rothwell, 1993). The Gnetales are a diverse assemblage of gymnosperms, including *Welwitschia* – with VAM, and *Gnetum* – the only known non-Pinaceae gymnosperm with ECM (Table 4). DNA sequence data shows that the Gnetales and Pinaceae are closely related and that flowering plants are not direct descendants of the Gnetales (Kenrick, 1999; Donoghue & Doyle, 2000). However, these phylogenetic relationships are not fully resolved due to conflicts with morphological and fossil evidence (Doyle, 1998).

The only true ECM fossils are from recent Middle Eocene materials (LePage *et al.*, 1997). Preserved imprints of roots thought to belong to plants in the Podocarpaceae from the Lower Cretaceous have characteristic short swollen lateral roots called 'mycorrhizal nodular roots' (Cantrill & Douglas, 1988). These were interpreted as ECM by some, but this is inconsistent with living podocarps that have VAM (Baylis *et al.*, 1963).

4. Angiosperms

Angiosperms probably arose in the Early Cretaceous (Stewart & Rothwell, 1993; Taylor & Taylor, 1993). It is believed that they initially occupied early successional habitats, as gymnosperms dominated the most productive plant communities (Wing & Boucher, 1998). The most primitive surviving angiosperms include the Amborellaceae, Austrobaileyaceae, Nymphaeaceae, Illiciaceae and Schisandraceae (Kuzoff & Gasser, 2000). The mycorrhizal status of most of these basal angiosperms has not been investigated, but *Nymphaea* has VAM (Brundrett, 1999).

The strongest evidence that VAM is the ancestral condition for angiosperms is provided its near-ubiquitous occurrence in them (Newman & Reddell, 1987; Trappe, 1987). Trappe (1987) compiled data for 6507 angiosperm species, of which 67% had VAM (including 12% considered to be facultative), 15% had another association type and 18% were NM (Fig. 2). Additional information for the UK flora (Harley & Harley, 1987). Hawaiian angiosperms (83% mycorrhizal – Koske

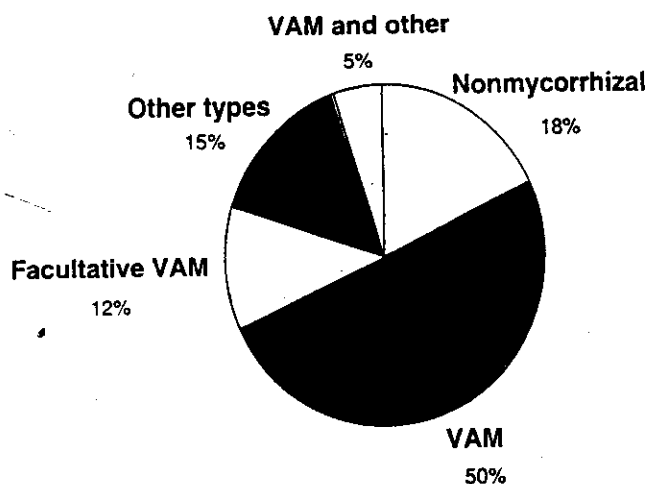

Fig. 2 Proportion of angiosperm species with different categories of mycorrhizal associations using data from Trappe (1987).

et al., 1992) and Australian plants (Brundrett, 1999) based primarily on plants from natural ecosystems have provided similar results.

The statement '90% of plants are mycorrhizal' has been widely presented in the literature, but is not based on scientific data. The actual proportion of angiosperms known to be mycorrhizal is somewhat lower than this (i.e. 82%). At the ecosystem level, the dominant plants in most natural habitats are mycorrhizal, but properties have rarely been determined (Brundrett, 1991). The relative cover of mycorrhizal plants in ecosystems ranges from 100% (96% VAM, 4% ECM, < 1% NM) in a Canadian deciduous forest (Brundrett & Kendrick, 1988) to 52% (35% VAM, 17% ECM, 45% NM) in an Australian eucalypt forest (Brundrett & Abbott, 1995), or 40% VAM in a disturbed habitat (Barni & Siniscalco, 2000). This type of analysis would show that ECM associations are far more important than indicated in taxonomic surveys, as they dominate many ecosystems (Brundrett, 1991).

Angiosperm phylogenies based on multiple gene sequence data (Soltis *et al.*, 2000), have allowed mycorrhizal lineages to be resolved (Fig. 3). These lineages include major clades (with multiple families) and minor clades (with a few families or genera) of plants with fairly consistent mycorrhizal associations. It is probable that the evolution of ECM coincides with the origin of the Fagales and Pinaceae in the Cretaceous (Table 3). The Fagales lineage includes the Betulaceae, Casuarinaceae, Juglandaceae, Myricaceae, Nothofagaceae, and Fagaceae (Chen *et al.*, 1999), most of which have ECM roots (Table 3).

Angiosperms other than the Fagales have evolved this ECM independently (Table 4; Fig. 3). These include some members of the Ericales and 11 families in 6 orders of the rosids. The highest frequency of ECM plants occurs in the rosid branch of the eudicots, but these orders also include many families of VAM plants, so they probably did not originate as ECM clades (Fig. 3). Fitter & Moyersoen (1996) suggest that ECM plants are concentrated in the rosids because there are many

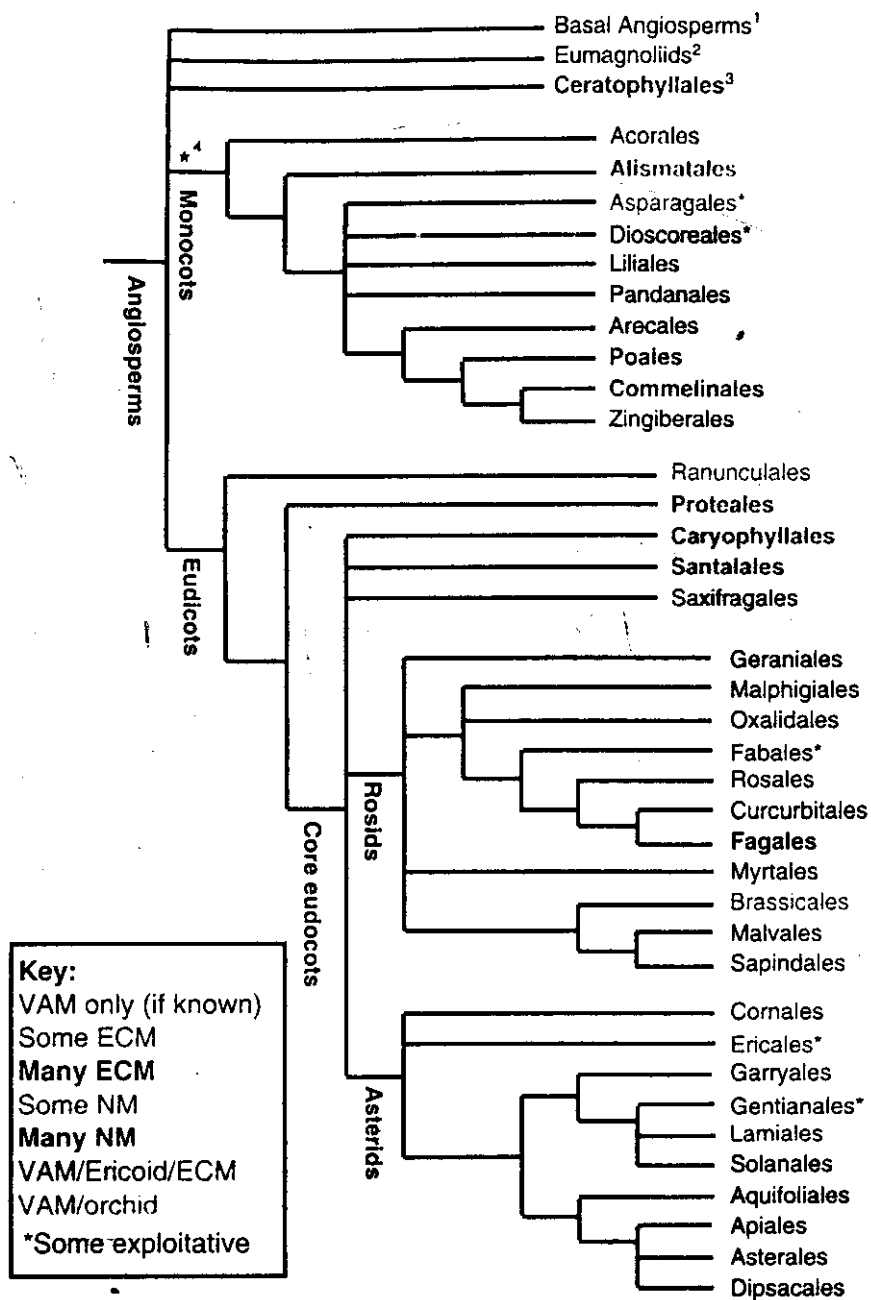

Fig. 3 Position of mycorrhizal lineages in a simplified angiosperm family tree (after APG (Angiosperm Phylogeny Group) (1988) and Soltis *et al.* (2000)). Information about the mycorrhizal status of families is compiled from many sources. (Notes: 1, Amborellaceae, Nymphaeaceae, etc.; 2, Chloranthales, Piperales, Laurales, Magnoliales and Winterales; 3, position of family varies widely in trees; 4, several unresolved monocot families with exploitative mycorrhizas.)

woody plants in this lineage. Many rosids grow in cool climates and soils with organic matter where ECM associations can be most effective (Section VII). Plant families with nitrogen fixing rhizobial or actinorhizal nodules are also concentrated in the rosids (Gualtieri & Bisseling, 2000).

The Dipterocarpaceae and Cistaceae are closely related families in the Malvales that may share an ECM ancestor. Several isolated lineages of ECM plants occur in otherwise NM families: the sedges (*Kobresia*: Cyperaceae) in the Poales and several genera in the Caryophyllales (*Neea*, *Pisonia*: Nyctaginaceae). Numerous ECM lineages occur in the Myrtales and Fabales (see below), but there likely also have been many reversions back to VAM in these groups.

The Ericales have the most complex evolutionary trends, starting from a VAM ancestor, progressing to ECM, then to arbutoid ECM and culminating in ericoid mycorrhizas, or exploitative ECM in myco-heterotrophs like *Monotropa* (Fig. 3). Ericoid mycorrhizas occur in the Ericaceae and Epacridaceae, but the latter is a clade within the former (Kron *et al.*, 1999). Fossil evidence suggests that plants with ericoid mycorrhizas are at least 80 Myr old (Table 4). Phylogenetically, plants with arbutoid ECM (*Gaultheria*, *Arbutus*, *Pyrola*) are the sister group to the Ericaceae, with ericoid mycorrhizal plants as their monophyletic descendants (Cullings, 1996). However, *Clethra* (Clethraceae), which is basal to the remaining Ericales (Cullings, 1996), has recently been shown to have VAM

(Kubota *et al.*, 2001), as does *Actinidia* (Actinidiaceae) their closest known sister group (Calvet *et al.*, 1989; Soltis *et al.*, 2000). Thus, the evolutionary sequence proposed by Cullings (1996) should be modified to show VAM as the basal state of the Ericales. Plants in the Ericaceae from Hawaii have re-acquired VAM, presumably because ericoid fungi were absent (Koske *et al.*, 1990). Cullings (1996) suggests that arbutoid mycorrhizas are intermediary between ECM and ericoid associations as they have common features. The switch to a new fungal lineage was probably the key event in the evolution of ericoid mycorrhizas, but the first ericoid fungi may have also been an ECM associate (Vrålstad *et al.*, 2000).

The Proteaceae and Restionaceae were present 100 Myr ago and may well have been some of the first plants with true NM roots capable of excluding mycorrhizal fungi (Section VI.5). There are at least 10 lineages of NM plants in the angiosperms, but most also contain many VAM plants. The Poales clade contains many predominantly NM families (Cyperaceae, Juncaceae, Xyridaceae, Restionaceae, etc.), but members of the Poaceae usually have VAM. It is possible that their common ancestor was NM and grasses re-acquired the capacity to host VAM. Alternatively, many Poales may have become NM due to radiation into habitats where mycorrhizas are not beneficial (Section VII). Families such as the Cyperaceae are predominantly NM, but contain some members with VAM (Table 2). Many of these 'NM families' also contain species that have either re-acquired the capacity for mycorrhizal formation, or never lost it entirely. It is likely that members of many NM lineages are polyphyletic and many reversions back to VAM have occurred (Section VII).

Families of predominantly NM plants include the Amaranthaceae, Brassicaceae, Caryophyllaceae, Chenopodiaceae, Commelinaceae, Cyperaceae, Juncaceae, and Polygonaceae (see lists in Tester *et al.*, 1987; Brundrett, 1991). Phylogenetic analysis shows that certain orders and families of plants are much more likely to contain NM members (Fig. 3). Most NM plants are herbaceous, but some are shrubs and trees (e.g. Proteaceae). Major NM clades that appear to be monophyletic include the Caryophyllales, Commelinales and Alismatales (Fig. 3). However, the Alismatales include many aquatic plants that may have independently lost their VAM due to root reduction and habitat factors (Section VI.5). Examples of minor clades of NM plants isolated within groups of VAM plants include the Brassicaceae, Dasygongonaceae, Papaveraceae, Proteaceae and Zygophyllaceae (Fig. 3). Lineages of parasitic plants like the Santalales and Lamiales have many NM members (Trappe, 1987; Lesica & Antibus, 1986), as do insectivorous plants in the Ericales and Lamiales (Lamont, 1982; Brundrett, 1999). NM plants generally are most abundant in harsh plant habitats, such as extremely wet, saline, or arid soils (Brundrett, 1991). Many epiphytes also are NM, but others have VAM, orchid or ericoid associations (Janos, 1993; Gemma & Koske, 1995). Unidentified ascomycetes in the roots of some

epiphytic ferns form an association that resembles ericoid mycorrhizas (Schmid *et al.*, 1995).

5. Partially or fully exploitative associations

Plants with exploitative mycorrhizas, which are called myco-heterotrophic or saprophytic, are considered to be fully reliant on mycorrhizal fungi due to the lack of photosynthesis and substantial roots (Björkman, 1960; Furman & Trappe, 1971; Leake, 1994). These 'achlorophyllous' plants have very low concentrations of photosynthetic pigments (Cummings & Welschmeyer, 1998). Isotope tracer studies have demonstrated nutrient transfer to *Monotropa* (Björkman, 1960) and *Corallorhiza* (McKendrick *et al.*, 2000) from trees or tree saplings, and transfer through hyphal connections was established for the latter. Leake (1994) provides a detailed account of the biology of myco-heterotrophic plants.

Plants with exploitative mycorrhizas have many separate lineages, demonstrating that increasing host control over associations is one of the most important trends in mycorrhizal evolution (Section III). These associations originated in several lineages of primitive plants including bryophytes and the gametophytes of *Lycopodium*, *Psilotum* and *Botrychium* (Section IV.2). Angiosperms with exploitative mycorrhizas are listed in Table 4. Data summarised by Leake (1994) and newer molecular phylogenies (Soltis *et al.*, 2000) show three separate origins for these associations in the dicots (Ericales, Polygalaceae, Gentianaceae) and three or more origins in the monocots (Burmanniaceae, Orchidaceae, Corsiciaceae, Petrosaviaceae, Truridaceae) (Fig. 3). The last three families remain unresolved in phylogenetic analyses and may be examples of convergent evolution. Cullings (1996) determined that myco-heterotrophy evolved twice in the Ericales, but most are monophyletic. Myco-heterotrophic angiosperms other than the orchids or Ericales have exploitative coiling VAM, without arbuscules in many cases (Table 2).

Molvray *et al.* (2000) show that myco-heterotrophy has evolved separately approximately 20 times in the orchids – more than in all other plants combined. It has been suggested that orchids have a greater tendency to evolve these associations, because they have myco-heterotrophic seedlings (Benzing & Arwood, 1984; Molvray *et al.*, 2000). Orchids also evolve more rapidly than other plant families (higher rates of base substitutions), so may switch to new strategies more often (Molvray *et al.*, 2000).

The tiny seeds of orchids are considered to be fully dependent on mycorrhizal fungi for germination, but adult plants are usually thought to be fully autotrophic (Hadley, 1982; Rasmussen, 1995). However, evidence that mycorrhizas of green orchids are partially exploitative is provided by ¹⁴C transfer experiments, the survival of achlorophyllous mutants of some orchid species, and the apparent below ground persistence of other orchids for years (Alexander & Hadley, 1985; Salmia, 1988; Rasmussen, 1995). There is no evidence that

fungi receive benefits from their associations with orchids (Section II).

The Apostasioids are considered to be the most primitive Orchidaceae (Stern & Warcup, 1994; Kristiansen *et al.*, 2001), but are probably not typical of early orchids (Chase, 2001). Close relatives of the orchids include the Asteliaceae, Blanfordiaceae, Boryaceae, Hypoxidaceae and Lanariaceae (Chase, 2001). Members of these families probably have VAM.

The switch to a new type of mycorrhizal fungus associate probably was the key defining event in the evolution of the Orchidaceae at least 100 Myr ago (Table 4). Orchids may well have evolved from an ancestor with a partially exploitative VAM association, as these have anatomical and functional similarities to orchid mycorrhizas (see below). The evolution of the orchid mycorrhizas is linked to extreme specialisation, since abundant microscopic seeds are required for dispersal into specialised habitats in patchy environments (Benzing & Atwood, 1984; Rasmussen, 2000). These 'dust seeds', in turn require myco-heterotrophic germination.

The Orchidaceae and Gentianaceae have species with differing levels of dependence on mycorrhizas, extending from fully autotrophic, balanced mycorrhizas to fully-heterotrophic, exploitative associations (Leake, 1994). The Gentianaceae show an evolutionary series where the hyphal coil interface gradually becomes more important, culminating in cases without any arbuscules (Schmid & Oberwinkler, 1994; Imhof, 1998, 1999b). Some members of the Gentianaceae require companion plants to support their VAM fungi (Jacquelinet-Jeanmougin & Gianinazzi-Pearson, 1983; McGee, 1985; Warcup, 1988). It seems likely that all mycorrhizal fungi may have some capacity to support exploitative plants. For example, VAM fungi can support growth of non-photosynthetic tobacco plants growing in the presence of other plants (Müller & Dulieu, 1998).

6. The evolution of mycorrhizas continues

Plants within a genus usually have the same type of mycorrhiza (ECM, VAM, etc.) or are NM, but there are many exceptions to this rule (Harley & Harley, 1987; Newman & Reddell, 1987; Alexander, 1989; Brundrett, 1999). A survey of Australian plants has provided insight into the consistency of mycorrhizas in plant families (Brundrett, 1999). Mycorrhizal associations are highly diverse in Australian plant families such as the Myrtaceae and Fabaceae. For example, the Fabaceae tribe Mirbelieae includes: plants with VAM; plants with dual ECM/VAM; NM plants with cluster roots; and VAM plants with cluster roots.

Genera with dual ECM/VAM associations include *Alnus*, *Acacia*, *Casuarina*, *Eucalyptus*, *Populus*, *Salix* and *Uapaca* (Lodge & Wentworth, 1990; Khan, 1993; Moyersoen & Fitter, 1998; Chen *et al.*, 2000). The occurrence of two types of mycorrhizas in the same root system raises important questions about the relative benefits they provide to plants (Lodge,

2000; van der Heijden, 2001). Some plants with dual ECM/VAM probably have only recently evolved the capacity to host ECM, as they have long thin, weakly dimorphic, relatively unbranched short roots with a shallow mantle and Hartig net (Brundrett *et al.*, 1996). It can be difficult to designate these associations using morphological criteria (MC Brundrett, unpublished), but benefits from these associations have been measured (McGee, 1988b). The VAM in plants with dual associations may be relictual (due to an inability to fully exclude them), functional (providing greater or wider access to nutrients), or a backup mechanism for situations when inoculum of ECM fungi is limited. Evidence for the last option is provided by plants with dual associations that only have substantial amounts of VAM when growing in disturbed habitats, flooded soils, or as young seedlings (Lapeyrie & Chilvers, 1985; Lodge & Wentworth, 1990; Bellei *et al.*, 1992; Chen *et al.*, 2000).

V. Evolution of roots

Most botanists believe that roots and stems are entirely separate organ systems, although it should be noted that some plants apparently have intermediate organs, that root-shoot interconversion can occur, and that roots and shoots have many shared developmental processes (Esau, 1965; Groff & Kaplan, 1988; Dolan & Scheres, 1998). Roots are morphologically unique among plant organs because they have a bidirectional meristem that produces both an apical root cap as well as the subapical root tissues (Esau, 1965; Foster & Gifford, 1974).

It is likely that roots evolved from the subterranean stems (rhizomes) of plants, as suggested in Fig. 4. An evolutionary series can be recognised, starting with coarse dichotomous branched roots (e.g. *Selaginella*), progressing to roots with an apical cell and more organised branching (ferns, *Equisetum*), continuing to gymnosperm roots with indistinct cell layers, and ending with angiosperm roots with the most highly organised cell layers and branching (Noelle, 1910; Foster & Gifford, 1974). However, we cannot be certain that there is a common ancestor for all plants with roots, or in which plant lineage roots first arose (Gensel *et al.*, 2001; Raven & Edwards, 2001). The roots of the primitive living vascular plants, such *Isoetes*, *Lycopodium* and *Selaginella*, are remarkably similar to the typical roots of angiosperms except that *Lycopodium* lacks an endodermis, and only *Selaginella* has an exodermis with Casparian bands (Damas *et al.*, 1997).

The first root-like fossils are from the Lower Devonian, but may be intermediate structures, as they do not seem to have a root cap (Gensel *et al.*, 2001; Raven & Edwards, 2001). It seems that true roots first appeared in several plant lineages (lycophods and ferns) that arose in Mid Devonian times during a period of rapid plant diversification and increasing complexity (Stewart & Rothwell, 1993; Taylor & Taylor, 1993; Kenrick & Crane, 1997; Gensel *et al.*, 2001). The mycorrhizal status of these structures is unknown.

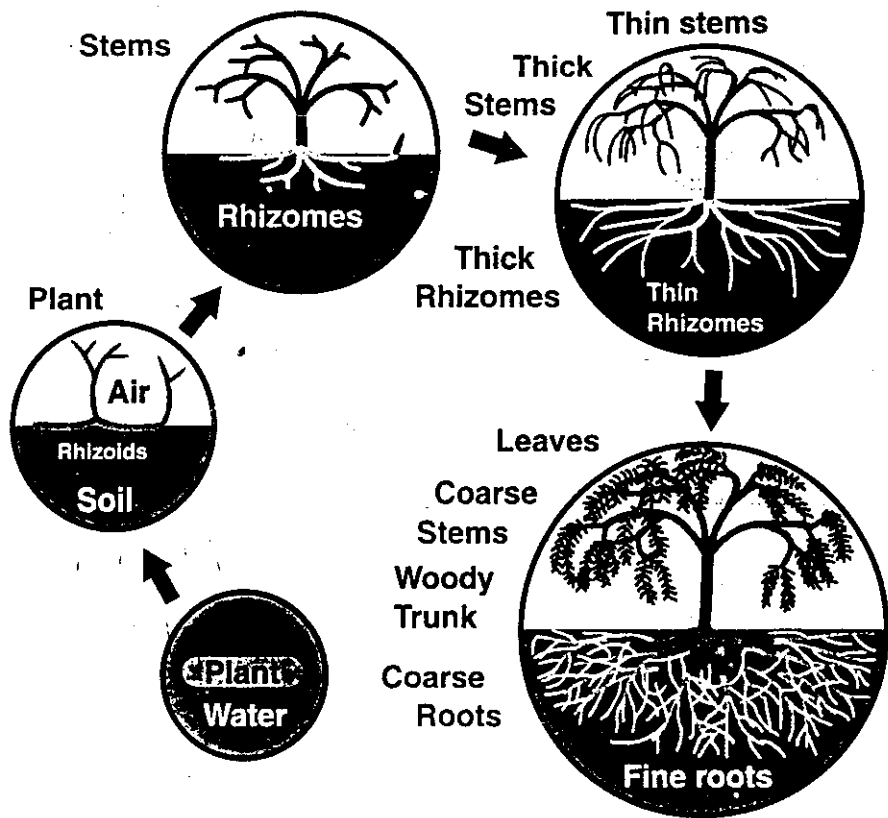

Fig. 4 Diagram summarising probable stages in the evolution of stems, rhizomes, leaves and roots from the thallus of an early bryophyte-like land plant, using a hypothetical final example with a woody trunk.

As plants colonised the land they would have faced powerful selection pressure to increase the surface area of their absorptive systems in soil in parallel with increases in their photosynthetic organs to acquire limiting mineral nutrients from soils.

The evolution of roots most likely started by differentiation of underground stems (rhizomes) into two specialised types: thicker perennial stems that support above-ground structures, propagate the plant, serve as storage organs, and form conduits to distribute water and nutrients; and thinner, longer absorbing structures to house mycorrhizal fungi and exploit a greater volume of soil (Fig. 4). The thin structures would have had to be replaced more often than thick stems, due to environmental stresses. The two types of underground stems would have continued to diverge, due to the selection pressures described above, by evolving separate phenologies, growth patterns, and structures, with most differentiation occurring in the thinner rhizomes. Evolutionary modifications to thick stems would include protective features that reduce permeability and exclude fungi, after mycorrhizal formation and nutrient absorption were no longer required. Root hairs probably evolved from the rhizoids of earlier plants to increase contact with the soil. At some stage the thinner, absorptive subterranean stems would have become roots. Support for the theory that roots gradually evolved from shoots is provided by the fact that many of the same genetic mechanisms are involved in the formation of these organs (Dolan & Scheres, 1998). An alternative theory that roots originated suddenly,

as a result of an infection by an agrobacterium-like organism has also been proposed (Harper *et al.*, 1991), but is highly improbable since this could only provide a small fraction of the genes required to form roots (Chriqui *et al.*, 1996).

Roots have continued to progressively evolve into a hierarchy of structures (branch orders), with the finest elements becoming progressively thinner and more diffuse. This structural heterogeneity culminates in fine high-order lateral roots that explore the soil volume. These are most highly developed in angiosperms with NM roots (Section VI). Low-order lateral roots are a more-permanent network used for mechanical support, production of fine roots and transport. Probable stages in the evolution of roots from rhizomes are summarised below:

- 1 Dimorphic subterranean rhizome systems evolve in response to the conflict between optimum designs for nutrient uptake, mycorrhiza formation, mechanical support and survival.
- 2 Some stems become thinner and longer to increase contact with the soil and absorptive capacity. These also grow faster, have a shorter lifespan and evolve a separate phenology.
- 3 Other rhizomes remain thick and evolve more protective features to limit permeability and facilitate long-term survival in soil.
- 4 Mycorrhizal formation is restricted to the thin rhizomes, which grow when fungi are active and can be renewed as required to provide sufficient habitat for mycorrhizas to meet plant nutrient requirements.

VI. The root as a habitat for fungi

Most of our knowledge of roots comes from studies of crops selected from weedy ancestors for rapid growth in highly fertile soils. Roots of annual crops can grow 1 cm or more a day and live for a few weeks or months (Russell, 1977), but roots of plants in natural ecosystems are likely to grow 1 mm or less a day and often live for years (Lyr & Hoffmann, 1967; Brundrett & Kendrick, 1988, 1990a). Perennial plants typically also have much more root structural diversity than annual plants (Brundrett & Kendrick, 1988). The cortex is usually protected by an exodermis with suberised and/or lignified walls forming a permeability barrier that probably also provide greater structural strength, drought tolerance, and reduced nutrient and water loss (Brundrett & Kendrick, 1988; Peterson, 1988; Perumalla *et al.*, 1990). The development of structural features is greatest in long-lived roots, but would increase their production costs and may restrict nutrient acquisition (Table 5).

The cortex is the largest organ of most primary roots but only seems to have an active role when roots are mycorrhizal (Fig. 5). With few exceptions (bryophytes, gametophytes, some orchids and myco-heterotrophs), plants only form mycorrhizas within a living root cortex or epidermis. Most cortex cells are highly vacuolated, unless occupied by a mycorrhizal fungus, in which case there is a many-fold increase in cytoplasm volume (Alexander *et al.*, 1989; Smith & Smith,

1990). The root cortex is also important for storage and transport, but these roles seem to require less volume, as cortex reduction typically follows the loss of mycorrhizas (see below).

The selection forces driving root evolution summarised in Table 5 primarily result from soil properties and would have started to act on plants when they left the water (Section III). In particular, soil immobilises nutrients, is prone to desiccation, and has mechanical impedance (Russell, 1977). Optimum design solutions to overcome these factors are often in conflict, so modern plants have evolved a range of different solutions to these challenges. For example, a root system optimised for nutrient uptake via mycorrhizas would be very different to one optimised for water uptake (Table 5).

1. Control of VAM

Structural features of roots that influence VAM formation are listed in Table 6. VAM fungi are attracted to young roots by soluble or volatile exudates including secondary metabolites like flavanoids (Giovannetti & Sbrana, 1998). Initial penetration of roots typically occurs in a zone where the exodermis is developing, so these fungi may be attracted to susceptible roots by phenolics involved in suberin synthesis (Brundrett & Kendrick, 1990b; Douds *et al.*, 1996). However, these signals are not essential, as root colonisation by VAM fungi is similar in roots without an exodermis.

Table 5 Selection forces driving the evolution of root form

Factor	Optimal root design
Habitat for VAM	<input type="checkbox"/> Thick roots maximise cortex area available for VAM fungi <input type="checkbox"/> A long life-span and well-protected cortex <input type="checkbox"/> Relatively slow root growth balanced with fungal activity
Habitat for ECM	<input type="checkbox"/> Dimorphic with short, highly branched, slow growing laterals
Direct uptake of immobile nutrients	<input type="checkbox"/> Long, fine and highly branched roots (extensive) <input type="checkbox"/> Rapid growth and frequent replacement of roots (active) <input type="checkbox"/> Absorb solutes and release exudates freely through root periphery (permeable)
Water and mobile nutrient uptake	<input type="checkbox"/> The surface area and age and distribution patterns in soil of roots are likely to be important <input type="checkbox"/> Mass flow of water driven by transpiration in leaves
Absorption of apoplast-mobile elements such as Ca	<input type="checkbox"/> Young roots with permeable tips required at times of shoot growth?
Cost minimisation	<input type="checkbox"/> Coarse and long-lived <input type="checkbox"/> Resistant to predation and stress <input type="checkbox"/> Limited exudation
Mechanical support of shoot	<input type="checkbox"/> Strong and thick, highly lignified roots
Resistance to predators and pathogens	<input type="checkbox"/> Physical defences: coarse and strong roots <input type="checkbox"/> Barriers (suberin lignin ⁻¹ tannins ⁻¹) in cell walls of the root periphery <input type="checkbox"/> Passive chemical defences: accumulation of protective secondary metabolites in cells <input type="checkbox"/> Active defensive responses
Tolerance to adverse soil conditions	<input type="checkbox"/> Coarse, strong and impermeable with outer barriers

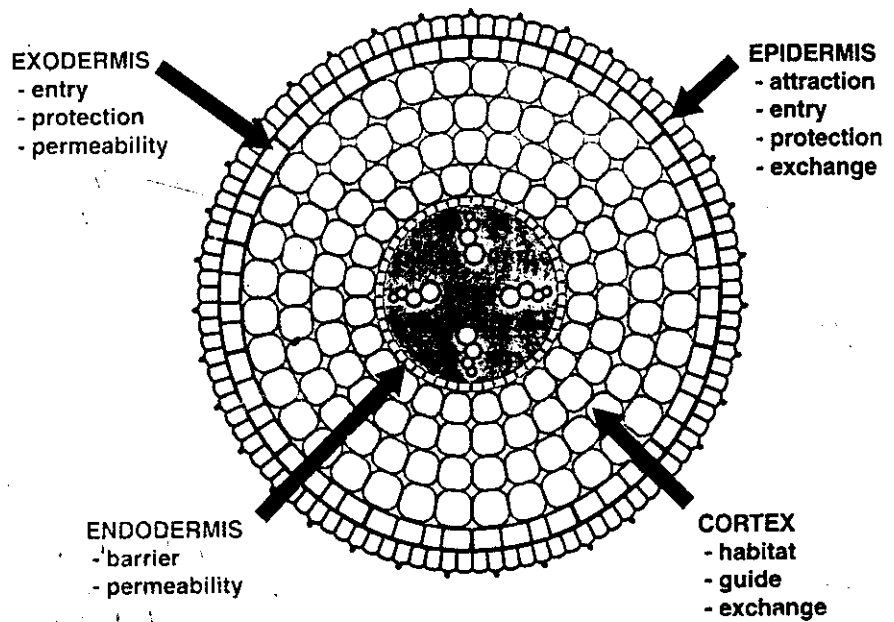

Fig. 5 Anatomical evidence that roots evolved as habitats for mycorrhizal fungi. This diagrammatic summary illustrates typical features of angiosperm plants and only concerns vesicular–arbuscular mycorrhizas.

Table 6 Root morphology characteristics which influence mycorrhiza formation

Association	Anatomical feature	Influence on mycorrhizas
VAM	Cortex air channels Cortex cell properties Epidermis and hypodermis structure Endodermal cells Root system architecture	Hyphal distribution and growth rates Arbuscule distribution Appressoria position and path of root penetration limit inward fungal growth Efficiency of mycorrhiza formation (Table 7)
ECM	Cell walls in hypodermis or cortex Root growth rate	Depth of Hartig net hyphae Mycorrhiza formation

VAM are only initiated near the apex of young roots (Hepper, 1985; Brundrett & Kendrick, 1990a; Smith *et al.*, 1992). Suberised exodermal cells regulate root penetration by VAM fungus hyphae (Table 6), which typically occurs before they suberise completely, or else occurs through specialised ‘passage cells’ in a dimorphic exodermis (Brundrett & Kendrick, 1990a,b). A dimorphic exodermis has alternating completely suberised long cells and short (passage) cells with suberin only in their radial walls (Shishkoff, 1987; Peterson, 1988). There are many reports of mycorrhizal fungi penetrating roots through short cells (e.g. Matsubara *et al.*, 1999).

Some plants with VAM (e.g. *Acer*, *Ulmus*, *Podocarps*) have dimorphic roots (called beaded roots) that can superficially resemble ECM (Baylis *et al.*, 1963; Duhoux *et al.*, 2001). Beads occur when fine laterals are divided into short segments by constrictions due to suberin deposition (metacutinization) occurring in root cap cell walls when growth is interrupted (Baylis *et al.*, 1963; Kessler, 1966; Brundrett *et al.*, 1990c). Beaded roots probably evolved because plants only required a small cortex volume to form mycorrhizas at any one time and had long-lived roots encased in suberin for protection.

Gallaud (1905) observed that VAM associations in different plant species conformed to two distinct morphology types

that he named the *Arum* and *Paris* series after two host plants. In roots with linear (*Arum* series) VAM, hyphae proliferate in the cortex by growing longitudinally between host cells, while in coiling (*Paris* series) VAM, hyphae spread primarily by coils within cells (see Fig. 1.11 of Brundrett *et al.*, 1996). This patterns arise because linear hyphae grow through longitudinally continuous air spaces when these are present and coils result otherwise (Brundrett *et al.*, 1985). Aerenchyma formation is greatest in roots growing in waterlogged soil (Armstrong, 1979), reducing the cortex volume that would be available for mycorrhizal fungi. There is an evolutionary trend for root loss in fully aquatic plants resulting in nutrient uptake through leaves (Sculthorpe, 1967). Mycorrhiza formation may be the most important evolutionary factor determining the presence of absence of air channels in roots, as the widespread occurrence of plants without them suggests that soil aeration is not a problem in most habitats.

Coiling VAM associations were once considered to be unusual, but both types are widely distributed in the plant kingdom (Smith & Smith, 1997). Coiling VAM is most common in bryophytes, ferns and gymnosperms, and thus is most likely to be their ancestral condition (Smith & Smith, 1997). However, it has also been suggested coiling VAM is more

advanced than linear VAM, since the former seems to allow the plant greater host control of the fungus and occurs in the most highly evolved myco-heterotrophic associations (Brundrett & Kendrick, 1990a,b; Imhof, 1999b). Mycorrhizal colonisation is most rapid and efficient in plants with linear VAM, but this may result in greater energy cost to the plant (Brundrett & Kendrick, 1990a,b). Experiments have demonstrated that the same fungus can form both types of association in different hosts and substantial growth responses result from both (Gerdemann, 1965). There also are morphological patterns of VAM associated with particular fungi (Abbott, 1982; Merryweather & Fitter, 1998). The importance of variations in VAM morphology are discussed elsewhere (Smith & Smith, 1997; MC Brundrett, unpublished).

The apoplastic (noncytoplasmic) space in the VAM root cortex is often delimited by the endodermis and exodermis (Fig. 5), which probably control solute transport into the mycorrhizal exchange zone and limit root exudation (allowing greater resources for mycorrhizal fungi). The exodermis also helps protect inactive fungi in roots as a reservoir of inoculum. The endodermis delimits the inward spread of VAM fungi, but is unlikely to be a physical barrier, as VAM formation often precedes suberin lamellae deposition, and these fungi cross passage cells with similar Casparian bands in the exodermis (Brundrett & Kendrick, 1990a,b). Abrupt changes in solutes or dissolved gases may prevent mycorrhizal fungi from crossing the endodermis.

2. Control of ECM

Ectomycorrhizal roots are elaborate structures that require time to develop, so the growth rates of lateral roots must be slow enough to allow fungi time to form associations (Chilvers & Gust, 1982). Like VAM, the interface of ECM degenerates after a few weeks, so renewal of roots would be required to maintain nutrient transfer (Downes *et al.*, 1992). Consequently, each lineage of plants with ECM has independently evolved dimorphic (heterorhizic) root systems with short roots characterised by limited apical growth and high branching densities (Wilcox, 1964; Kubiková, 1967; Brundrett *et al.*, 1990c). Within a host plant, the degree of branching in ECM short roots varies with different mycorrhizal fungi (Godbout & Fortin, 1985; Newton, 1991). It is thought that plant growth regulators supplied by the ECM fungus influence root swelling, extension and branching, as these chemicals can induce similar changes in the absence of fungi (Kaska *et al.*, 1999). These root architecture trends are dramatically illustrated by hosts with dual associations which have much lower specific root length when growing with ECM fungi than when they associate with VAM fungi (Chen *et al.*, 2000). A substantial proportion of the root system of woody plants consists of older roots with a periderm that cannot form mycorrhizas (Lyr & Hoffman, 1967).

There are considerable variations in the structure and

function of ECM roots formed by different fungi with one host plant (Agerer, 1995). This results in a continuum of increasing ECM root biomass and structural complexity, starting with diffuse superficial associations (Section IV.6), and culminating in tuberculate ECM associations with highly branched and compact roots (Trappe, 1965; Haug *et al.*, 1991; Brundrett *et al.*, 1996). This evolutionary complexity continuum reflects increasing investment in mycorrhizal associations by both the plant and fungus that would only occur if these partnerships are essential.

Root anatomy can have a substantial impact on ECM morphology (Table 6; see Fig. 1.12 of Brundrett *et al.* (1996) for illustrations). Associations of angiosperms like *Eucalyptus*, *Betula*, *Populus*, *Fagus* and *Shorea* have a Hartig net confined to epidermal cells, while the Hartig net of gymnosperms like *Pinus* extends into the cortex (Alexander & Högberg, 1986; Kottke & Oberwinkler, 1986; Massicotte *et al.*, 1987). Angiosperms with a cortical Hartig net are rare, but *Dryas* is an exception (Melville *et al.*, 1987). Epidermal ECM roots often have an exodermis, but it may not become suberised until after the Hartig net forms, so other aspects of the composition of walls in this cell layer probably block hyphal penetration (Ling-Lee *et al.*, 1977; Brundrett *et al.*, 1990c). In some gymnosperms the penetration of Hartig net hyphae into the inner cortex is stopped by cells with thickened walls (Brundrett *et al.*, 1990c), or changes in the carbohydrate composition of cell walls (Nylund, 1987).

The suberised exodermis in epidermal ECM roots can be a permeability barrier controlling passage of solutes into and out of the Hartig net zone, and the fungal mantle can also be a solute barrier (Vesk *et al.*, 2000). The mantle structure varies considerably with different colonising fungi (Agerer, 1995) and may often be too diffuse to influence root permeability. Proteins secreted on the surface of hyphae called hydrophobins are one factor likely to influence fungal sheath permeability (Tagu *et al.*, 2001), but secretions that cement hyphae together seem more important (Vesk *et al.*, 2000). Some plants have a relatively thin Hartig net on epidermal cells with wall ingrowths (transfer cells), while other hosts have swollen roots with enlarged epidermal cells without wall ingrowths in the interface zone (Ashford & Allaway, 1982; Massicotte *et al.*, 1987). Hosts with an epidermal Hartig net, such as *Quercus* and *Betula* species, usually have a relatively narrow cortex with cells that can be massively lignified (see Fig. 1.12 in Brundrett *et al.* (1996)), perhaps as an adaptation to withstand hydraulic pressure.

Many angiosperm plant lineages with ECM have independently evolved from plants with VAM (Fig. 3), but all show convergent evolution in root morphology, resulting in dimorphic root systems, thickened short roots, Hartig net epidermal cell enlargement and a thin strengthened cortex. Associations with epidermal and cortical Hartig nets are two fundamentally different categories of ECM, and it should not be assumed that they are functionally equivalent. As is the case

with linear and coiling categories of VAM, the same fungus can form both types of ECM with different hosts (Massicotte *et al.*, 1989). The epidermal associations probably arose because most angiosperm families with ECM had an exodermis with walls that resisted hyphal penetration, while gymnosperms did not have this layer. However, the ECM morphology of gymnosperm roots could also result from the absence of a clearly organised epidermal layer (Noelle, 1910; Brundrett *et al.*, 1990c).

3. Other types of mycorrhizas

Orchid mycorrhizal associations have hyphal coils in host cells with few morphological signs that the fungi are specialised root inhabitants, in contrast with VAM and ECM which have host–fungus interface of highly specialised hyphae. Many orchids have very coarse roots with limited branching. Extreme examples are provided by autotrophic genera of West Australian terrestrial orchids, such as *Pterostylis* and *Caladenia* with few or no roots, that form mycorrhizas in a short stem segment just below the soil surface (Ramsay *et al.*, 1986). These orchids grow in highly infertile soils where it would be impossible for them to acquire sufficient mineral nutrients without mycorrhizal fungi. Myco-heterotrophic orchids usually have highly reduced roots (Leake, 1994).

Ericoid mycorrhizas have coils of relatively undifferentiated hyphae like those of orchid mycorrhizas, but occur within extremely narrow ‘hair roots’ (Smith & Read, 1997). These roots have no cortex and have mycorrhizal associations in epidermal cells. Hair roots are even finer than the ultimate lateral roots of most facultatively mycorrhizal or NM plants (see below), but their capacity to absorb nutrients directly is not known.

4. Roots of facultatively mycorrhizal plants

Plant species generally have either: consistently high levels of mycorrhizas; intermediate, or variable levels of mycorrhizas; or are not mycorrhizal (Janos, 1980; Trappe, 1987; Brundrett, 1991). These categories of plants are designated as obligately mycorrhizal, facultatively mycorrhizal, or nonmycorrhizal (NM), respectively, to reflect varying degrees of benefits received from mycorrhizal associations (see Janos, 1980; Brundrett, 1991; Marschner, 1995). Facultative mycorrhizal plants are balanced plant–fungus associations, but the benefits to plants are conditional on soil fertility (MC Brundrett, unpublished). Roots of NM plants are considered separately below.

The root-shoot ration of plants is regulated by source-sink carbon flow relationships and hormonal means (Farrar & Jones, 2000). The uptake of relatively immobile elements such as phosphorus by plants is dependant on the surface area of their absorbing structures in the soil, but the uptake of water and more mobile nutrients is less dependant on surface area (Russell, 1977; Marschner, 1995). Mineral nutrients (especially phosphorus and nitrogen) are amongst the most important limiting factors for plant growth in natural ecosystems

(Brundrett, 1991), and provide most of the benefits of mycorrhizal associations measured in experiments (Marschner, 1995; Smith & Read, 1997).

The main role of mycorrhizal associations is to acquire nutrients by exploring the soil volume with hyphae that are both more responsive and more extensive than the roots themselves (Harley, 1989). However, some plants have highly branched, fine, long roots with numerous root hairs that are also capable of effectively exploring large soil volumes and responding to temporary soil resources (Baylis, 1975; Manjunath & Habte, 1991; Schweiger *et al.*, 1995; Koide *et al.*, 2000). These diffuse root systems are typical of plants in natural habitats with low levels of mycorrhizal colonisation, while highly mycorrhizal plants tend to have coarse root systems (Brundrett & Kendrick, 1988; Hetrick *et al.*, 1992; Fitter & Moyersoen, 1996). Plants at the obligate mycorrhizal end of this continuum also tend to have roots that grow more slowly and live longer and thus would not be responsive to changes in nutrient availability (Table 7). Coarse roots typically live longer than fine roots (Eissenstat, 1992). The capacity of plants to respond to small, temporary changes in water or nutrient availability by growing new roots is an important determinant of their competitive ability (St. John *et al.* 1983, Fitter & Hay, 1987; Graham *et al.*, 1991). Assuming that soil nutrient levels are not unusually high and inoculum of appropriate mycorrhizal fungi are available, the root features listed in Table 7 will determine the magnitude of benefits plants receive from their mycorrhizas. Plants with facultative associations would not be able to support both high levels of mycorrhizal colonisation and fine/active root systems, because of the high metabolic cost that would result. The diffuse nature and shorter lifespan of fine root systems is likely to equate to much higher construction costs.

5. The divergence of roots of nonmycorrhizal plants

Only a brief discussion of this complex topic is provided here and readers should consult other reviews for more information (Tester *et al.*, 1987; Brundrett, 1991; Koide & Schreiner, 1992; Giovannetti & Sbrana, 1998). These plants normally have fine, active, extensive roots systems like those of facultative plants (Table 7). Some NM plants have evolved specialised root systems, such as cluster roots, which secrete organic compounds to modify the pH of the rhizosphere in order to increase nutrient availability, as well as dauciform and sand-binding roots, whose functions are less certain (Lamont, 1982; Marschner, 1995; Skene, 1998). Pemberton *et al.* (2001) found several different patterns of root hair production occur in eudicots, and one type where hairs occur in linear files, primarily occurred in the Caryophyllales and Brassicales, suggesting this type of root hair formation evolved in NM plants.

The principle characteristic of the roots of NM plants is the capacity to exclude glomalean fungi. Factors in the rhizosphere of non-host plants inhibit spore germination, hyphal

Typical trends of root features	Mycorrhizal dependency continuum	
	High	Low
Surface area of absorbing roots ^a	Low	High
1. Root length/biomass ratio ^b	Low	High
2. Lateral root branching orders	Few	More
3. Branching frequency	Sparse	Frequent
4. Root hairs	Few/short	Many long ⁻¹
Root system activity	Low	High
1. Root growth	Slow	Fast
2. Responsiveness ^c	Slow	High
Root lifespan (in primary growth)	Months/years	Weeks/months
Protective features		
1. Structural ^d	Well developed	Weakly developed
2. Chemical ^e	Relatively primitive	Relatively advanced
Rhizosphere influences ^f	Slight	May occur
Root activity at low temperature	Usually stops	Often considerable
Formation of mycorrhizas	Efficient	Inefficient
	Well regulated	May be inhibited

Table 7 Generalised relationships between features of root systems and the mycorrhizal dependency of plants (after Brundrett, 1991)

Notes: a, relative to plant biomass; b, specific root length; c, roots respond to temporary or localised soil conditions; d, suberisation or lignification of primary root structures; e, accumulated secondary metabolites may be relatively primitive (tannins, etc.) or advanced (alkaloids, cyanogens, etc.); f, that influence the availability of soil nutrients.

growth and appressoria formation by VAM fungi, and these roots rarely contain arbuscules (Tommerup, 1984; Koide & Schreiner, 1992; Fontenla *et al.*, 1999). Roots of NM plants are less attractive to VAM fungi, but some of these fungi still attempt colonisation, forming abortive appressoria on the surface of their roots (Douds *et al.*, 1996; Giovannetti & Sbrana, 1998). It has also been suggested that non-host roots fail to trigger fungal genes responsible for symbiotic interactions (Giovannetti & Sbrana, 1998), but it seems more likely that fungi attempt to go through the normal stages in mycorrhizal formation and are blocked by defence reactions of non-host roots. Clearly visible wounding reactions at attempted entry points occur in NM roots of some plants (Allen *et al.*, 1989).

Further evidence for the role of defence reactions is provided by the existence of NM mutants of mycorrhizal plants (Giovannetti & Sbrana, 1998; Wegel *et al.*, 1998; Gao *et al.*, 2001). These mutants block most VAM fungi in peripheral layers of their roots, but some fungi can produce arbuscules in the cortex, demonstrating that the greatest impact is on early events in VAM formation (Wegel *et al.*, 1998; Gao *et al.*, 2001). Presumably, both mutants and true NM plants have the same defence response to mycorrhizal fungi that they would have to pathogens that attempt to colonise roots. These defences seem to decline in effectiveness with time as endophytic growth by VAM hyphae is common in older roots of NM plants (Brundrett, 1991). These defences can also be switched off by a sublethal herbicide dose (Schwab, 1982). Some host plants also have the capacity to block colonisation by mycorrhizal fungi in highly fertile soils, apparently by a wounding response in exodermal cells (Mosse, 1973).

Root chemistry is the key to understanding NM plants, which often accumulate chemicals, such as alkaloids and cyanogenic glucosinolates, considered to be evolutionarily advanced (Brundrett, 1991; Koide & Schreiner, 1992; Vierheilig *et al.*, 2000). This contrasts with mycorrhizal plants that are more likely to contain primitive chemical components, such as phenolics, that may be used by mycorrhizal fungi to detect susceptible roots (Brundrett, 1991; Douds *et al.*, 1996; Giovannetti & Sbrana, 1998). The potential role of secondary metabolites in regulating mycorrhizal relationships would depend on many factors that could influence their effectiveness (Brundrett, 1991; Vierheilig *et al.*, 2000). Mechanisms for the exclusion of mycorrhizal fungi from NM plant roots are worthy of further investigation and may include a wide range of potent antifungal agents that await discovery (Brundrett, 1991).

Plants in NM families typically grow in harsh or disturbed habitats where mycorrhizal fungi would be of limited benefit, due to soil conditions such as waterlogging or salinity (Trappe, 1987; Brundrett, 1991; Allen *et al.*, 1995; Fitter & Moyersoen, 1996). In these cases the exclusion of mycorrhizal fungi would conserve energy (Section VII). NM plants would typically expend more energy on root activity than mycorrhizal species, but are not supporting a fungus.

Probable stages in NM plant evolution from facultatively mycorrhizal plants with suitable roots for direct nutrient uptake are listed below. It is likely that several stages are involved in the evolution of NM plants and the first stage may be rapid, while the second and third would be much slower. Thus there could be several different types of NM plants with differing mechanisms and capacities for excluding fungi.

- 1 One or more mutations result in the loss of recognition mechanisms for mycorrhizal fungi, so attempted mycorrhizal formation activates defence reactions to fungal invasion. These plants may not be fully NM.
- 2 Plants gradually evolve potent new defences against fungi, often by accumulating antifungal chemicals, to increase their capacity to efficiently exclude both mycorrhizal and pathogenic fungi from roots.
- 3 Roots lose 'primitive' structural and chemical defences that are no longer required.

6. Conclusions

Each type of mycorrhiza is associated with a characteristic type of root system. Coarse, slow growing, long-lived, relatively thick roots are typical of plants with obligate VAM associations and are most common in the plant kingdom. Convergent evolution of plants with facultative mycorrhizas results in much finer and more active roots than plants with obligate mycorrhizas. Facultatively mycorrhizal plants have sacrificed root cortex volume to attain greater surface area and a greater capacity to explore the soil. These plants have traded efficient mycorrhizal associations for the capacity to grow without them in fertile soils, but still benefit from mycorrhizas in infertile soils. Fungi would have to expend more energy forming associations in these highly diffuse root systems, because of an increased number of entry points for mycorrhizal fungi relative to the cortex space they occupy. The root growth of mycorrhizal plants cannot greatly exceed the growth capacity of soil hyphae. Thus, the evolution of roots of mycorrhizal plants would be constrained by the need to form efficient associations.

Early land plants without roots probably had a limited ability to regulate fungal associations (Section III). Roots allow plants greater control over mycorrhizal fungi by confining them in certain cell layers and controlling the timing of their formation (Section V). Plants ultimately control the extent of mycorrhizal formation by regulating root growth and turnover (Tisserant *et al.*, 1996). Thus, active mycorrhizal associations will only occur during periods of root growth. Most perennial plants only replace a fraction of their roots each year. This would prevent energy expenditure above what is required to meet current demands for nutrients.

Some plants with fine root systems have evolved the capacity to exclude mycorrhizal fungi from their roots and become NM plant lineages. The chemical and structural divergence of NM roots suggests that the evolution of root properties in mycorrhizal plants has been restricted by the need to remain compatible with mycorrhizal fungi. Mycorrhizal plants cannot evolve potent new defences against fungal pathogens if these also inhibit mycorrhizal fungi. It is not known how plants with one type of mycorrhiza exclude fungi of other types when they occur together, or how strong are the preferences of fungi for roots of their host plants.

VII. Mycorrhizal evolution trends

Figure 6 attempts to chart the evolutionary history (direction and frequency of switching) for all existing types of mycorrhizas. All other types of mycorrhizal associations are ultimately derived from plants with VAM, but some have passed through several intermediate stages. Overall, the most common changes in mycorrhizal status are from VAM to facultative VAM, then to NM, or from VAM, to dual ECM/VAM, then to ECM. The reverse situation, where ECM or NM roots re-acquire VAM appears to be uncommon. However, several plant lineages may have reversions back to an ancestral condition, such as mycorrhizal plants in NM plant lineages (Section IV.7), suggesting they retained or re-acquired the capacity for mycorrhiza formation. Plants with a new type of mycorrhiza would retain the capacity to host their first association for some time, as is the case of plants with dual ECM/VAM (Section IV.6).

Evolutionary trends in mutualism/symbiosis appear to be much more complex than models and theoretical discussions would suggest. Evolution has resulted in consistent mycorrhizas in most plant families, but there are exceptions to this generalisation such as families of plants that seem to be in a transitional state between ECM and VAM (Section IV.6). Some lineages of plants that started with one type of association have diverged in several separate directions (Fig. 6). For example, many plants with VAM have close relatives with NM or ECM roots, and some families have highly complex mycorrhizal relationships (Section IV.5). Plants that switch mycorrhiza types seem to be more likely to switch again and would already have many of the capacities required by to form mycorrhizas (Section IV). Plants use some of the same genes to regulate nitrogen fixing and mycorrhizal associations (Bonfante & Perotto, 1995; Gualtieri & Bisseling, 2000), and some of these mechanisms are also likely to be shared between several types of mycorrhizas. Many lineages of exploitative mycorrhizas have originated from plants with VAM, arbutoid ECM or orchid mycorrhizas (Section IV.5).

Mycorrhizal evolution can be summarised by contrasting the oldest association (VAM) with more recently evolved associations to look for general trends. Increasing control of associations by the host along with increasing interface complexity is the strongest evolutionary trend (Section VI), but host and habitat specificity of fungi also often increases with time (Section II). Facultative mycorrhizas, where plants become less dependent on fungi, and exploitative associations, where plants become more dependent on fungi, occupy the opposite poles of an evolutionary continuum, with balanced associations in the centre.

The need for compatibility with slowly evolving VAM fungi apparently constrained root structural and chemical evolution for most plant species (Section VI). Evolutionary advances in root morphology result in greater control of fungi and their confinement to smaller zones within plants, culminating in the reduced organs of plants with exploitative

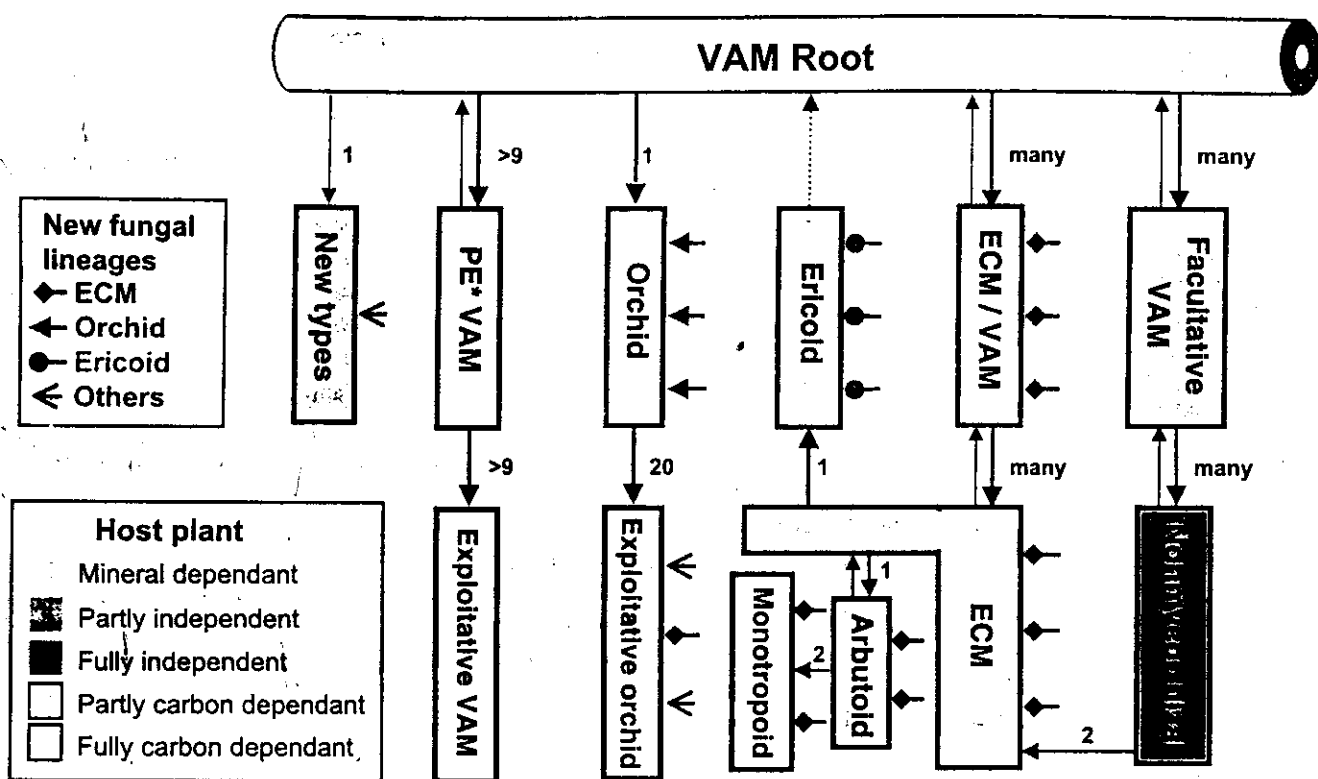

Fig. 6 Summary of mycorrhizal lineages of plants and fungi and the mycorrhizal dependency of plants. Approximate numbers of new plant lineages are shown beside arrows. Boxes and arrow widths are not to scale. (PE = partially exploitative).

mycorrhizas (Section VI). In ECM this trend starts with dual VAM/ECM and culminates in some of the most complex of all mycorrhizal associations (Section IV.2). Each type of mycorrhiza has characteristic root morphology (Section VI). Convergent evolution has resulted in dimorphic roots for plants with ECM, and extensive roots with long root hairs for facultatively mycorrhizal or NM plants.

Four different evolutionary categories of fungi can be recognised (Section II). The Glomales are a single unique ancient lineage, in contrast with other fungi that have multiple origins and coevolve with plants much more rapidly. Some plants may continue to acquire new fungal lineages. Most lineages of mycorrhizal fungi arise from saprophytes with enzymes that can penetrate plant cell walls that presumably first became endophytes after attraction to roots by exudates (Section III). New types of mycorrhizas do not always result from the adoption of new lineages of fungi, as some myco-heterotrophs exploit ECM fungi or saprophytes (Section II). Orchid mycorrhizal fungi may not benefit from associations with orchids and thus would not coevolve with plants, or form separate lineages from their saprophytic or parasitic relatives. The nature of ericoid fungi is also uncertain (Section II).

Theoretical models of symbiotic evolution are based on animal systems with vertical transmission (codispersal) that evolve from parasitic interactions (Genkai-Kato & Yamamura, 1999). However, phylogenetic studies show that most mycorrhizal fungi do not have parasitic ancestors (Section II). They also

lack vertical transmission, since their inoculum is present in most soils, they efficiently disperse into new habitats (Lu *et al.*, 1999), or can occur without host plants. Plants with ECM tend to have large seeds that are likely to recruit near their parents where fungi would already be present (similar to vertical transmission) (Wilkinson, 1997). However, seed size and dispersal mechanisms are poorly correlated with the mycorrhizal status of plants in other cases (Allsopp & Stock, 1995).

Most plants have mycorrhizas even though theoretical studies suggest there will be major conflicts of interests and both partners require means to prevent the other from cheating (Schwartz & Hoeksema, 1998; Herre *et al.*, 1999). It has been suggested that symbiotic partners will avoid conflicts if one utilises waste materials produced by the other (Genkai-Kato & Yamamura, 1999). The substances exchanged by mycorrhizal partners are not waste products, but may be present in excess of immediate requirements (Section III). Consequently, the costs of production/acquisition of these substances must be balanced against the benefits provided by associations. Models that use currency exchange ideas provide the most realistic means of assessing relative costs and benefits of mycorrhizal associations (Gryndler, 1992; Schwartz & Hoeksema, 1998; Herre *et al.*, 1999). The benefits of exchanging photosynthates for mineral nutrients have outweighed the costs for the majority of plants since they first colonised land.

The host-fungus interface of mycorrhizal associations may have evolved, in part, as a mechanism to limit cheating by

tightly coupling the costs and benefits from exchange for both partners. This process seems to be primarily controlled by plants, which can escape from their obligations by myco-heterotrophy, but cases where mycorrhizal fungi exploit plants appear to be rare (when grown at natural nutrient levels). Plant mechanisms for preventing unwanted colonisation may not be specific enough to distinguish cheaters from beneficial fungi. The only effective mechanism for plants to stop fungi from absorbing photosynthates without providing benefits is to tightly couple gains and losses through simultaneous exchange across a common interface. This may explain why both VAM and ECM evolved a complex interface with active exchange of limited duration. The loss of cost-benefit coupling occurs in exploitative mycorrhizas, but is rare otherwise because the dominant plants in natural ecosystems cannot afford to cheat as their success is interdependent with that of their fungi.

Exploitative associations are the pinnacle of mycorrhizal evolution, where the fungus replaces both the roots and leaves of plants. The roles of plants and fungi in exploitative associations do not correspond to normal definitions of mycorrhizas (MC Brundrett, unpublished). These plants, have no commodities that can be used for exchange with fungi (Section VII) and very complex host–fungus interfaces that function by means we do not understand (MC Brundrett, unpublished). Myco-heterotrophy often comes with a change in fungal partners (e.g. orchids associating with wood rotting or ECM fungi), and some fungi involved in these associations have no specialisations for life within plants (Table 3). The fact that exploitative associations have arisen many times suggests that both ECM and VAM fungi have a built in capacity to support myco-heterotrophic plants. It seems that mycorrhizal fungi have a very limited capacity to distinguish roots of different plant species, suggesting that plants primarily regulate specificity. We might expect ECM fungi to be better at avoiding these traps, because they are often host specific, but this is not the case.

A gradual transition from autotrophy to heterotrophy occurs in some plant families, but there are other cases, such as achlorophyllous orchid mutants that have jumped from a high degree of autotrophy to full myco-heterotrophy in one step (Rasmussen, 1995). Exploitative mycorrhizas seem to be an evolutionary dead end due to highly specific habitat requirements and the irreversible loss of photosynthesis. Most have extremely high host–fungus specificity, so can only grow in soil patches where a particular fungus thrives (Furman & Trappe, 1971). These plants also tend to lose lignified tissues, as in Ericales that became herbaceous plants (Kron *et al.*, 1999). Myco-heterotrophic plants tend to grow in deep shade where there is insufficient light for photosynthetic plants (Leake, 1994). Some adult green terrestrial orchids may be less dependent on sunlight for energy than other plants, but this requires further investigation (Rasmussen, 1995; McKendrick, 1996). One of the most important advantages provided by

exploitative mycorrhizal associations may be the capacity to grow in dark places. The requirement for other plants to support their fungal networks would also help explain why myco-heterotrophic plants are never dominant in natural ecosystems, and tend to be over-represented in threatened species lists. It has been proposed that myco-heterotrophic plants provide some symbiotic benefits to associated fungi (Bidartondo *et al.*, 2000), but this is unrealistic if the costs/benefits of these associations are considered.

The evolution of novel nutrient uptake mechanisms, such as new types of mycorrhizas or NM cluster roots, coincided with the origin of many plant families which apparently became more competitive, or were able to occupy new habitats. We would assume that these mechanisms provided a selective advantage due to increased nutrient uptake efficiency relative to association costs. In the Paleozoic, the evolution of novel nutrient uptake mechanisms (ECM, NM, etc.) may have played an important role in the eventual domination of angiosperms over more primitive VAM plants (gymnosperms, ferns, etc.) in many habitats. Several theories attempt to explain why angiosperms became dominant, but none are conclusively supported by the available evidence (Barrett & Willis, 2001). The increasing importance of angiosperms was gradual and probably involved climatic changes and disturbance (Hill *et al.*, 1999). These phytogeographic trends are complex, because both angiosperm (e.g. *Nothofagus*) and gymnosperm trees (Pinaceae) with ECM become dominant in some regions, while plants with VAM remained dominant in many others. It seems likely that, new root functional capabilities may be partially responsible for the success of ECM angiosperms and gymnosperms in cool forests and NM angiosperms such as the Proteaceae and Cyperaceae in disturbed habitats. Climatic and soil factors are also important, as in cooler climates ECM trees tend to be dominant in soils with organic nutrients, while VAM-trees are more important in soils with mineral nutrients (Brundrett, 1991). The situation in tropical regions is more complex, as ECM and VAM dominated forests occur in the same regions on similar soils (Högberg & Alexander, 1995; Newbery *et al.*, 1997; Moyersoen *et al.*, 1998). Additional examples of plant-habitat/soil-mycorrhizal fungus coevolution include the tendency for NM plants to occur in wet, saline, dry, or cold habitats (Section IV).

Plants have had VAM associations (or something very similar) since they first colonised land in the Early Paleozoic, and these associations seem to have changed very little in the hundreds of millions of years since roots evolved (Section IV). The slow rate of Glomalean fungus evolution may be matched to the early plants they first associated with (Section II). One possible explanation for their continuing success is that fungi forming newer association types may be less tolerant to changes in environmental conditions and would lose any advantages they have gained from a higher degree of coevolution with plants during periods of climate change. Glomalean fungi may coevolve with their soils more than

they do with their hosts, and may evolve so slowly that they barely adjust to changes in climate as continents move, ice ages come and go, and poles shift. Perhaps we should consider VAM to be a long-term strategy that incorporates the flexibility to cope with both present and future environmental conditions. The Glomales are arguably the most important group of all living organisms, but are also one of the most enigmatic. We lack fundamental knowledge of their genetics, lifecycles, interactions with other organisms, capacities to adjust to changing soils or climates, or how to define individuals and species.

Acknowledgements

The author gratefully acknowledges supported by the Australian Research Council and Botanic Gardens & Parks Authority. This review is dedicated to my wife Karen Clarke for her love and companionship and for surviving months as a computer widow. I am also very grateful to Chelsea Dog, my constant companion throughout the process (asleep in the desk drawer). I particularly thank the many people with whom I have had fascinating discussions about mycorrhizas over the years. Stephen Imhof, Patricia Gensel, Manuela Giovannetti, Carol Peterson, Anne Pringle, Arthur Schüßler, Thomas N. Taylor, Katarzyna Turnau provided information. Valuable assistance was provided by Bernadette Waugh and Linley Thorner of the CSIRO library in Floreat. I am also very grateful to Jim Trappe, Penny Hollick, Matt Barrett, Trevor Hein and the anonymous reviewers who provided many comments on earlier versions of this manuscript.

Note added in proof

Several important references concerning mycorrhizal evolution which have recently come to my attention are listed below. The VAM fungi should now collectively be referred to as the Glomeromycota not the Glomales (Schüßler *et al.*, 2001).

- Cairney JWG. 2000. Evolution of mycorrhiza systems. *Naturwissenschaften* 87: 467–475.
- Halling RE. 2001. Ectomycorrhizae: co-evolution, significance, and biogeography. *Annals of the Missouri Botanical Garden* 88: 5–13.
- Heckman DS, Geiser DM, Eidell BR, Stauffer RL, Kardos NL, Hedges SB. 2001. Molecular evidence for the early colonisation of land by fungi and plants. *Science* 293: 1129–1133.
- Schüßler A, Schwarzott D, Walker C. 2001. A new fungal phylum, the Glomeromycota: phylogeny and evolution. *Mycological Research* 105: 1413–1421.

References

- Abbott LK. 1982. Comparative anatomy of vesicular-arbuscular mycorrhizas formed on subterranean clover. *Australian Journal of Botany* 30: 485–499.
- Abbott LK, Robson AD, Gazey C. 1992. Selection of inoculant vesicular-arbuscular mycorrhizal fungi. In: Norris JR, Read DJ, Varma AK, eds. *Methods in microbiology*, vol. 24. *Techniques for the study of mycorrhiza*. London, UK: Academic Press, 1–21.
- Agerer R. 1995. Anatomical characteristics of identified ectomycorrhizas: an attempt towards a natural classification. In: Varma A, Hock B, eds. *Mycorrhiza*. Berlin, Germany: Springer Verlag, 685–734.
- Alexander IJ. 1989. Systematics and ecology of ectomycorrhizal legumes. In: Stirton CH, Zarucchi JL, eds. *Advances in legume biology*. St Louis, MO, USA: Missouri Botanical Garden, 607–624.
- Alexander C, Hadley G. 1985. Carbon movement between host and mycorrhizal endophyte during the development of the orchid *Goodyera repens* Br. *New Phytologist* 101: 657–665.
- Alexander IJ, Höglberg P. 1986. Ectomycorrhizas of tropical Angiosperms. *New Phytologist* 102: 541–549.
- Alexander T, Toth R, Meier R, Weber HC. 1989. Dynamics of arbuscule development and degeneration in onion, bean, and tomato with reference to vesicular-arbuscular mycorrhizae in grasses. *Canadian Journal of Botany* 67: 2505–2513.
- Allen MF, Allen EB, Friese CF. 1989. Responses of the non-mycotrophic plant *Salsola kali* to invasion by vesicular-arbuscular mycorrhizal fungi. *New Phytologist* 111: 45–49.
- Allen EB, Allen MF, Helm DJ, Trappe JM, Molina R, Rincon E. 1995. Patterns and regulation of mycorrhizal plant and fungal diversity. *Plant and Soil* 170: 47–62.
- Allsopp N, Stock WD. 1995. Relationships between seed reserves, seedling growth and mycorrhizal responses in 14 related shrubs (Rosidae) from a low-nutrient environment. *Functional Ecology* 9: 248–254.
- APG (Angiosperm Phylogeny Group). 1998. An ordinal classification for the families of flowering plants. *Annals of the Missouri Botanical Garden* 85: 531–553.
- Armstrong W. 1979. Aeration in higher plants. In: Woolhouse HW, ed. *Advances in botanical research*. London, UK: Academic Press, 225–332.
- Ashford AE, Allaway WG. 1982. A sheathing mycorrhiza on *Pisonia grandis* R. BR. (Nyctaginaceae) with development of transfer cells rather than a Hartig net. *New Phytologist* 90: 511–519.
- Barni E, Siniscalco C. 2000. Vegetation dynamics and arbuscular mycorrhiza in old-field succession of the western Italian Alps. *Mycorrhiza* 10: 63–72.
- Barrett PM, Willis JW. 2001. Did dinosaurs invent flowers? Dinosaur-angiosperm coevolution revisited. *Biological Reviews* 76: 411–447.
- Baylis GTS. 1975. The magnolioid mycorrhiza and mycotrophy in root systems derived from it. In: Sanders FE, Mosse B, Tinker PB, eds. *Endomycorrhizas*. New York, USA: Academic Press, 373–389.
- Baylis GTS, McNabb RFR, Morrison TM. 1963. The mycorrhizal nodules of podocarps. *Transactions of the British Mycological Society* 46: 378–384.
- Beck-Nielsen D, Madsen TV. 2001. Occurrence of vesicular-arbuscular mycorrhiza in aquatic macrophytes from lakes and rivers. *Aquatic Botany* 71: 141–148.
- Bell TL, Pate JS. 1996. Nitrogen and phosphorus nutrition in mycorrhizal Epacridaceae of South-west Australia. *Annals of Botany* 77: 389–397.
- Bellei MM, Garbaye J, Gil M. 1992. Mycorrhizal succession in young *Eucalyptus viminalis* plantations in Santa Catarina (south Brazil). *Forest Ecology and Management* 54: 205–213.
- Bending GD, Read DJ. 1997. Lignin and soluble phenolic degradation by ectomycorrhizal and ericoid fungi. *Mycological Research* 101: 1348–1355.
- Benzing DH, Atwood JT Jr. 1984. Orchidaceae: ancestral habitats and current status in forest canopies. *Systematic Botany* 9: 155–165.
- Berbee ML, Taylor JW. 1993. Dating the evolutionary radiations of the true fungi. *Canadian Journal of Botany* 71: 1114–1127.
- Berch SM, Kendrick B. 1982. Vesicular-arbuscular mycorrhizae of southern Ontario ferns and fern-allies. *Mycologia* 74: 769–776.
- Bidartondo MI, Kretzer AM, Pine EM, Bruns TD. 2000. High root concentrations and uneven ectomycorrhizal diversity near *Sarcodes sanguinea* (Ericaceae): a cheater that stimulates its victims? *American Journal of Botany* 87: 1783–1788.

- Björkman E. 1960. *Monotropia hypopitys* L. – an epiparasite on tree roots. *Physiologia Plantarum* 13: 308–327.
- Bonfante P, Perotto S. 1995. Strategies of arbuscular mycorrhizal fungi when infecting host plants. *New Phytologist* 130: 3–21.
- Bonfante-Fasolo P, Fontana A. 1985. VAM fungi in *Ginkgo Biloba* roots: their interactions at cellular level. *Symbiosis* 1: 53–67.
- Bougher NL, Fuhrer BA, Horak E. 1994. Taxonomy and biogeography of Australian *Rozites* species mycorrhizal with *Nothofagus* and Myrtaceae. *Australian Systematic Botany* 7: 353–375.
- Bougher NL, Lebel T. 2000. Sequestrate (truffle-like) fungi of Australia and New Zealand. *Australian Systematic Botany* 14: 439–484.
- Boullard B. 1979. Considerations sur la symbiose fongique chez les Pteridophytes. *Syllogus* 19: 1–58.
- Brundrett MC. 1991. Mycorrhizas in natural ecosystems. In: Macfayden A, Begon M, Fitter AH, eds. *Advances in ecological research, vol. 21*. London, UK: Academic Press, 171–313.
- Brundrett MC. 1999. *Introduction to mycorrhizas*. [WWW document]. URL <http://www.ffp.csiro.au/research/mycorrhiza>.
- Brundrett MC, Abbott LK. 1995. Mycorrhizal fungus propagules in the jarrah forest. II. Spatial variability in inoculum levels. *New Phytologist* 131: 461–469.
- Brundrett MC, Abbott LK, Jasper DA. 1999. Glomalean mycorrhizal fungi from tropical Australia. I. Comparison of the effectiveness and specificity of different isolation procedures. *Mycorrhiza* 8: 305–314.
- Brundrett M, Bougher N, Dell B, Grove T, Malajczuk N. 1996. *Working with mycorrhizas in forestry and agriculture*. ACLAR Monograph 32. Canberra, Australia: Australian Centre for International Agricultural Research.
- Brundrett MC, Kendrick WB. 1988. The mycorrhizal status, root anatomy, and phenology of plants in a sugar maple forest. *Canadian Journal of Botany* 66: 1153–1173.
- Brundrett MC, Kendrick WB. 1990a. The roots and mycorrhizae of herbaceous woodland plants. I. Quantitative aspects of morphology. *New Phytologist* 114: 457–468.
- Brundrett MC, Kendrick WB. 1990b. The roots and mycorrhizae of herbaceous woodland plants. II. Structural aspects of morphology. *New Phytologist* 114: 469–479.
- Brundrett MC, Murase G, Kendrick B. 1990c. Comparative anatomy of roots and mycorrhizae of common Ontario trees. *Canadian Journal of Botany* 68: 551–578.
- Brundrett MC, Piché Y, Peterson RL. 1985. A developmental study of the early stages in vesicular–arbuscular mycorrhiza formation. *Canadian Journal of Botany* 63: 184–194.
- Bruns TD, Read DJ. 2000. *In vitro* germination of nonphotosynthetic, myco-heterotrophic plants stimulated by fungi isolated from the adult plants. *New Phytologist* 148: 335–342.
- Calvet C, Pera J, Estaun V, Camprub A. 1989. Vesicular-Arbuscular mycorrhizae of kiwifruit in an agricultural soil inoculation of seedlings and hardwood cuttings with *Glomus mosseae*. *Agronomie* 9: 181–186.
- Cameron KM, Chase MW, Whitten WM, Kores PJ, Jarrell DC, Albert VA, Yukawa T, Hills HG, Goldman DH. 1999. A phylogenetic analysis of the Orchidaceae: evidence from rbcL nucleotide sequences. *American Journal of Botany* 86: 208–224.
- Cantrill DJ, Douglas JG. 1988. Mycorrhizal conifer roots from the Lower Cretaceous of the Otway Basin, Victoria. *Australian Journal of Botany* 36: 257–272.
- Castellano MA, Bougher NL. 1994. Consideration of the taxonomy and biodiversity of Australian ectomycorrhizal fungi. *Plant and Soil* 159: 37–46.
- Castellano MA, Trappe JM. 1985. Mycorrhizal associations of five species of Monotropoideae in Oregon. *Mycologia* 77: 499–502.
- Cázarez E, Luoma DL, Amaranthus MP, Chambers CL, Lehmkuhl JF, Halpern CB, Raphael MG. 1999. Interaction of fungal sporocarp production with small mammal abundance and diet in Douglas-fir stands of the southern Cascade range. *Northwest Science* 73: 64–76.
- Chambers SM, Williams PG, Seppelt RD, Cairney JWC. 1999. Molecular identification of *Hymenoscyphus* sp. from the rhizoids of the leafy liverwort *Cephalosilla exiflora*. Australia and Antarctica. *Mycological Research* 103: 286–288.
- Chase MW. 2001. The origin and biogeography of Orchidaceae. In: Pridgeon AM, Cribb PJ, Chase MW, eds. *Genera Orchidacearum, vol. 2. Orchidoideae (Part 1)*. Oxford, UK: Oxford University Press, 1–5.
- Chen YL, Dell B, Brundrett MC. 2000. Effects of ectomycorrhizas and vesicular–arbuscular mycorrhizas, alone or in competition, on root colonization and growth of *Eucalyptus globulus* and *E. urophylla*. *New Phytologist* 146: 545–556.
- Chen Z-D, Manchester SR, Sun H-Y. 1999. Phyogeny and evolution of the Betulaceae as inferred from DNA sequences, morphology, and paleobotany. *American Journal of Botany* 86: 1168–1181.
- Chilvers GA, Gust LW. 1982. Comparison between the growth rates of mycorrhizas, uninfected roots and a mycorrhizal fungus of *Eucalyptus sr-johnii* R. T. Bak. *New Phytologist* 91: 453–466.
- Chriqui D, Guivarch A, Dewitte W, Prinsen E, van Onkelen H. 1996. Root genes and root initiation and development. *Plant and Soil* 187: 47–55.
- Cooper KM. 1976. A field survey of mycorrhizas in New Zealand Ferns. *New Zealand Journal of Botany* 14: 169–181.
- Cordier C, Pozo MJ, Barea JM, Gianinazzi S, Gianinazzi-Pearson V. 1998. Cell defence responses associated with localized and systemic resistance to *Phytophthora parasitica* induced in tomato by an arbuscular mycorrhizal fungus. *Molecular Plant–Microbe Interactions* 11: 1017–1028.
- Cullings KW. 1996. Single phylogenetic origin of ericoid mycorrhizae within the Ericaceae. *Canadian Journal of Botany* 74: 1896–1909.
- Cullings KW, Azaro TM, Bruns TD. 1996. Evolution of extreme specialisation within a lineage of ectomycorrhizal epiparasites. *Nature* 379: 63–66.
- Cummings MP, Welschmeyer NA. 1998. Pigment composition of putatively achlorophyllous angiosperms. *Plant Systematics and Evolution* 210: 105–111.
- Currah RS, van Dyk M. 1986. A survey of some perennial vascular plant species native to Alberta for occurrence of mycorrhizal fungi. *Canadian Field-Naturalist* 100: 330–342.
- Currah RS, Zelmner CD, Hambleton S, Richardson KA. 1997. Fungi from orchid mycorrhizas. In: Arditti J, Pridgeon AM, eds. *Orchid biology: reviews and perspectives, VII*. Dordrecht, The Netherlands: Kluwer Academic Publishers, 117–170.
- Damas M, Peterson RL, Enstone DE, Peterson CA. 1997. Modifications of the cortical cells in roots of seedless vascular plants. *Botanica Acta* 110: 190–195.
- Dhillon SS. 1993. Vesicular–arbuscular mycorrhizas of *Equisetum* species in Norway and the USA: occurrence and mycotrophy. *Mycological Research* 97: 656–660.
- Dolan L, Scheres B. 1998. Root pattern: Shooting in the dark. *Cell and Developmental Biology* 9: 201–206.
- Donoghue MJ, Doyle JA. 2000. Seed plant phylogeny: demise of the anthrophyte hypothesis? *Current Biology* 10: 106–109.
- Douds D, Djr Nagahashi G, Abney GD. 1996. The differential effects of cell wall-associated phenolics, cell walls, and cytosolic phenolics of host and non-host roots on the growth of two species of AM fungi. *New Phytologist* 133: 289–294.
- Downes GM, Alexander IJ, Cairney JWG. 1992. A study of ageing of spruce [*Picea sitchensis* (Bong.) Carr.] ectomycorrhizas. I. Morphological and cellular changes in mycorrhizas formed by *Tylospora fibrillosa* (Burt. Donk) and *Paxillus involutus* (Batsch. ex Fr.) Fr. *New Phytologist* 122: 141–152.
- Doyle JA. 1998. Molecules, morphology, fossils, and the relationship of Angiosperms and Gnetales. *Molecular Phylogenetics and Evolution* 9: 448–462.
- Duckett JG, Ligrone R. 1992. A light and electron microscope study of the fungal endophytes in the sporophyte and gametophyte of *Lycopodium cernuum* with observations of the gametophyte-sporophyte junction. *Canadian Journal of Botany* 70: 58–72.

- Duckett JG, Read DJ. 1995. Ericoid mycorrhizas and rhizoid-ascomycete associations in liverworts share the same mycobiont: isolation of the partners and resynthesis of the associations *in vitro*. *New Phytologist* 129: 439–447.
- Duhoux E, Rinaudo G, Diem HG, Aguy F, Fernandez D, Bogusz D, Franche C, Dommergues Y, Huguenin B. 2001. Angiosperm *Gymnostoma* trees produce root nodules colonized by arbuscular mycorrhizal fungi related to *Glomus*. *New Phytologist* 149: 115–125.
- Eissenstat DM. 1992. Costs and benefits of constructing roots of a small diameter. *Journal of Plant Nutrition* 15: 763–782.
- Erland S, Taylor AFS. 1999. Resupinate ectomycorrhizal fungal genera. In: Cairney JWG, Chambers SM, eds. *Ectomycorrhizal fungi: key genera in profile*. Heidelberg, Germany: Springer-Verlag, 347–363.
- Esau K. 1965. *Plant anatomy*. New York, USA: John Wiley and Sons, Inc.
- Evans RD, Johansen JR. 1999. Microbiotic crusts and ecosystem processes. *Critical Reviews in Plant Sciences* 18: 183–225.
- Farrar JF, Jones DL. 2000. The control of carbon acquisition by roots. *New Phytologist* 147: 34–53.
- Fassi B. 1957. Ectomycorrhizie chez le *Gnerum africanum* Welw. due a *Scleroderma* sp. *Bulletin of the de Societe Francoise Mycologie* 73: 280–285.
- Fitter AH, Hay RKM. 1987. *Environmental physiology of plants*. London, UK: Academic Press.
- Fitter AH, Moyersoen B. 1996. Evolutionary trends in root-microbe symbioses. *Philosophical Transactions of the Royal Society of London Series B* 351: 1367–1375.
- Fontana A. 1963. Micorrizze ectotrofica in una Ciperacea: *Kobresia bellardi* degl. *Giornale Botanica Italiano* 70: 639–641.
- Fontenla S, Garcia-Romera I, Ocampo JA. 1999. Negative influence of non-host plants on the colonization of *Pisum sativum* by the arbuscular mycorrhizal fungus *Glomus mosseae*. *Soil Biology and Biochemistry* 31: 1591–1597.
- Foster AS, Gifford EM Jr. 1974. *Comparative morphology of vascular plants*. San Francisco, CA, USA: W.H. Freeman.
- Furman TE, Trappe JM. 1971. Phylogeny and ecology of mycotrophic achlorophyllous Angiosperms. *Quarterly Review of Biology* 46: 219–275.
- Gallaud I. 1905. Études sur les mycorrhizes endophytes. *Revue Generale de Botanique* 17: 5–500.
- Gao L-L, Delp G, Smith SE. 2001. Colonisation patterns in a mycorrhiza-defective mutant tomato vary with different arbuscular-mycorrhizal fungi. *New Phytologist* 151: 477–491.
- Gardes M, Bruns TD. 1996. Community structure of ectomycorrhizal fungi in a *Pinus muricata* forest: above- and below-ground views. *Canadian Journal of Botany* 74: 1572–1583.
- Gargas A, Depriest PT, Grube M, Tehler A. 1995. Multiple origins of lichen symbioses in fungi suggested by SSU rDNA phylogeny. *Science* 268: 1492–1495.
- Gebauer G, Taylor AFS. 1999. ¹⁵N natural abundance in fruit bodies of different functional groups of fungi in relation to substrate utilization. *New Phytologist* 142: 93–101.
- Gehrig H, Schußler A, Kluge M. 1996. *Geosiphon pyriforme*, a fungus forming endocytobiosis with *Nostoc* (cyanobacteria), is an ancestral member of the Glomales: evidence by SSU rRNA analysis. *Journal of Molecular Evolution* 43: 71–81.
- Gemma JN, Koske RE. 1995. Mycorrhizae in Hawaiian epiphytes. *Pacific Science* 49: 175–180.
- Gemma JN, Koske RE, Flynn T. 1992. Mycorrhizae in Hawaiian Pteridophytes: occurrence and evolutionary significance. *American Journal of Botany* 79: 843–852.
- Genkai-Kato M, Yamamura N. 1999. Evolution of mutualistic symbiosis without vertical transmission. *Theoretical Population Biology* 55: 309–323.
- Gensel PG, Kotyk M, Basinger JF. 2001. Morphology of above- and below-ground structures in early Devonian (Pragian-Emsian). In: Gensel PG, Edwards D, eds. *Plants invade land: evolutionary and environmental perspectives*. New York, USA: Columbia University Press, 83–102.
- Gerdemann JW. 1965. Vesicular-arbuscular mycorrhizae of maize and tulipree by *Endogone fasciculata*. *Mycologia* 57: 562–575.
- Giovannetti M, Sbrana C. 1998. Meeting a non-host: the behaviour of AM fungi. *Mycorrhiza* 8: 123–130.
- Godbout C, Fortin JA. 1985. Synthesised ectomycorrhizae of aspen: fungal genus level of structural characterisation. *Canadian Journal of Botany* 63: 252–262.
- Graham JH, Eissenstat DM, Drouillard DL. 1991. On the relationship between a plant's mycorrhizal dependency and rate of vesicular-arbuscular mycorrhizal colonization. *Functional Ecology* 5: 773–779.
- Groff PA, Kaplan DK. 1988. The relation of root systems to shoot systems in vascular plants. *The Botanical Review* 54: 387–422.
- Gryndler M. 1992. The ecological role of mycorrhizal symbiosis and the origin of the land plants. *Ceska Mykologie* 46: 93–98.
- Gualtieri G, Bisseling T. 2000. The evolution of nodulation. *Plant Molecular Biology* 42: 181–194.
- Hadley G. 1982. Orchid mycorrhiza. In: Arditti J, ed. *Orchid biology reviews and perspectives II*. Ithaca, NY, USA: Cornell University Press, 85–118.
- Hall IR. 1976. Vesicular mycorrhizas in the orchid *Corybas macranthus*. *Transactions of the British Mycological Society* 66: 160.
- Hall IR. 1977. Species and mycorrhizal infections of New Zealand Endogonaceae. *Transactions of the British Mycological Society* 68: 341–356.
- Handreck KA. 1997. Phosphorus requirements of Australian native plants. *Australian Journal of Soil Research* 35: 241–289.
- Harley JL. 1989. The fourth benefactors' lecture the significance of mycorrhiza. *Mycological Research* 92: 129–139.
- Harley JL, Harley EL. 1987. A check-list of mycorrhiza in the British flora. *New Phytologist* 105(2): 1–102.
- Harper JL, Jones M, Sackville Hamilton NR. 1991. The evolution of roots and the problems of analysing their behaviour. In: Atkinson D, ed. *Plant growth an ecological perspective*. Oxford, UK: Blackwell Scientific Publications, 3–22.
- Harrison MJ. 1999. Molecular and cellular aspects of the arbuscular mycorrhizal symbiosis. *Annual Review of Plant Physiology and Plant Molecular Biology* 50: 361–389.
- Hass H, Taylor TN, Remy W. 1994. Fungi from the Lower Devonian Rhynie chert: mycoparasitism. *American Journal of Botany* 81: 29–37.
- Haug I, Weber R, Oberwinkler F, Tschen J. 1991. Tuberculate mycorrhizas of *Castanopsis borneensis* King and *Engelhardtia roxburghiana* Wall. *New Phytologist* 117: 25–35.
- van der Heijden EW. 2001. Differential benefits of arbuscular mycorrhizal and ectomycorrhizal infection of *Salix repens*. *Mycorrhiza* 10: 185–193.
- Hepper CM. 1985. Influence of age of roots on the pattern of vesicular-arbuscular mycorrhizal infection in leek and clover. *New Phytologist* 101: 685–693.
- Herre ES, Knowlton N, Mueller UG, Rechner SA. 1999. The evolution of mutualisms: exploring the paths between conflict and cooperation. *Trends in Ecology and Evolution* 14: 49–53.
- Hetrick BAD, Wilson GWT, Todd TC. 1992. Relationship of mycorrhizal symbiosis, rooting strategy, and phenology among tallgrass prairie forbs. *Canadian Journal of Botany* 70: 1521–1428.
- Hibbert DS, Gilbert LB, Donoghue M. 2000. Evolutionary instability of ectomycorrhizal symbiosis in basidiomycetes. *Nature* 407: 506–508.
- Hill RS, Truswell EM, McLoughlin S, Dettmann ME. 1999. Evolution of the Australian flora. *Fossil Evidence*. In: Orchard EA, Thompson HS, eds. *Flora of Australia, Vol. 1 Introduction, 2nd edn*. Melbourne, Australia: CSIRO/ABRS, 105–124.
- Högberg P, Alexander IJ. 1995. Roles of root symbioses in African woodland and forest: evidence from ¹⁵N abundance and foliar analysis. *Journal of Ecology* 83: 217–224.

- Högberg P, Plamboeck AH, Taylor AFS, Fransson PMA. 1999. Natural ^{13}C abundance reveals trophic status of fungi and host-origin of carbon in mycorrhizal fungi in mixed forests. *Proceedings of the National Academy of Sciences, USA* 96: 8534–8539.
- Horton TR, Bruns TD. 1998. Multiple-host fungi are the most frequent and abundant ectomycorrhizal types in a mixed stand of Douglas fir (*Pseudotsuga menziesii*) and bishop pine (*Pinus muricata*). *New Phytologist* 139: 331–339.
- Hosney M, Hijri M, Passerieux E, Dulieu H. 1999. rDNA units are highly polymorphic in *Scutellospora castanea* (Glomales Zygomycetes). *Gene* 266: 61–71.
- Imhof S. 1998. Subterranean structures and mycotrophy of the achlorophyllous *Triuris hyalina* (Triuridaceae). *Canadian Journal of Botany* 76: 2010–2019.
- Imhof S. 1999a. Anatomy and mycotrophy of the achlorophyllous *Afrothisia winkleri* (Engl.) Schltr. (Burmanniaceae). *New Phytologist* 144: 533–540.
- Imhof S. 1999b. Root morphology, anatomy and mycotrophy of the achlorophyllous *Voyria aphylla* (Jacq.) Pers. (Gentianaceae). *Mycorrhiza* 9: 33–39.
- Imhof S. 1999c. Subterranean structures and mycorrhiza of the achlorophyllous *Burmannia tenella* Benthham (Burmanniaceae). *Canadian Journal of Botany* 77: 637–643.
- Jacobson KM, Jacobson PJ, Miller OK Jr. 1993. The mycorrhizal status of *Welwitschia mirabilis*. *Mycorrhiza* 3: 13–17.
- Jacquelinet-Jeanmougin S, Gianinazzi-Pearson V. 1983. Endomycorrhizas in the Gentianaceae I. the fungi associated with *Gentiana lutea* L. *New Phytologist* 95: 663–666.
- Janos DP. 1980. Mycorrhizae influence tropical succession. *Biotropica* 12: 56–64.
- Janos DP. 1993. Vesicular–arbuscular mycorrhizae of epiphytes. *Mycorrhiza* 4: 1–.
- Jansa J, Vosátka M. 2000. In vitro and post vitro inoculation of micropropagated Rhododendrons with cricoid mycorrhizal fungi. *Applied Soil Ecology* 15: 125–136.
- Johnson PN. 1977. Mycorrhizal Endogonaceae in a New Zealand forest. *New Phytologist* 78: 161–170.
- Jonsson L, Dahlberg A, Nilsson MC, Kårén O, Zackrisson O. 1999. Continuity of ectomycorrhizal fungi in self-regenerating boreal *Pinus sylvestris* forests studied by comparing mycobiont diversity on seedlings and mature trees. *New Phytologist* 142: 151–162.
- Kaska DD, Myllylä R, Cooper JB. 1999. Auxin transport inhibitors act through ethylene to regulate dichotomous branching of lateral root meristems in pine. *New Phytologist* 142: 49–58.
- Kenrick P. 1999. The family tree flowers. *Nature* 402: 358–359.
- Kenrick P, Crane PR. 1997. The origin and early evolution of plants on land. *Nature* 389: 33–39.
- Kessler KJ. 1966. Growth and development of mycorrhizae of sugar maple (*Acer saccharum* Marsh.). *Canadian Journal of Botany* 44: 1413–1425.
- Khan AG. 1993. Occurrence and importance of mycorrhizae in aquatic trees of New South Wales, Australia. *Mycorrhiza* 3: 31–38.
- Kohlmeyer J, Kohlmeyer E. 1979. *Marine Mycology The Higher Fungi*. London, UK: Academic Press.
- Kohzu A, Yoshioka Tando T, Takahashi M, Koba K, Wada E. 1999. Natural ^{13}C and ^{15}N abundance of field-collected fungi and their ecological implications. *New Phytologist* 144: 323–330.
- Koide RT, Goff MD, Dickie IA. 2000. Component growth efficiencies of mycorrhizal and nonmycorrhizal plants. *New Phytologist* 148: 1563–1168.
- Koide RT, Schreiner RP. 1992. Regulation of the vesicular–arbuscular mycorrhizal symbiosis. *Annual Review of Plant Physiology and Molecular Biology* 43: 557–581.
- Kope HH, Warcup JH. 1986. Synthesized ectomycorrhizal associations of some Australian herbs and shrubs. *New Phytologist* 104: 591–599.
- Koske RE. 1984. Spores of VAM fungi inside spores of VAM fungi. *Mycologia* 76: 853–862.
- Koske RE, Friese CF, Olexia PD, Hauke RI. 1985. Vesicular–arbuscular mycorrhizas in *Equisetum*. *Transactions of the British Mycological Society* 85: 350–353.
- Koske RE, Gemma JN, Englander L. 1990. Vesicular–arbuscular mycorrhizae in Hawaiian Ericales. *American Journal of Botany* 77: 64–68.
- Koske RE, Gemma JN, Flynn T. 1992. Mycorrhizae in Hawaiian Angiosperms: a survey with implications for the origin of the native flora. *American Journal of Botany* 79: 853–862.
- Kottke I, Oberwinkler F. 1986. Mycorrhiza of forest trees – structure and function. *Trees* 1: 1–24.
- Kretzer AM, Bidartondo MI, Grubisha LC, Spatafora JW, Szaro TM, Bruns TD. 2000. Regional specialisation of *Sarcodes sanguinea* (Ericaceae) on a single fungal symbiont from the *Rhizopogon ellenaec* (Rhizopogonaceae) species complex. *American Journal of Botany* 87: 1778–1782.
- Kretzer AM, Bruns TD. 1999. Use of atp6 in fungal phylogenetics: An example from the Boletales. *Molecular Phylogenetics and Evolution* 13: 483–492.
- Kretzer A, Li Y, Szaro T, Bruns TD. 1996. Internal transcribed spacer sequences from 38 recognized species of *Suillus sensu lato*: Phylogenetic and taxonomic implications. *Mycologia* 88: 776–785.
- Kristiansen KA, Rasmussen FN, Rasmussen HN. 2001. Seedlings of *Neuwiedia* (Orchidaceae subfamily Apostasioideae) have typical orchidaceous mycotrophic protocorms. *American Journal of Botany* 88: 956–959.
- Kron KA, Fuller R, Crayn DM, Gadek PA, Quinn CJ. 1999. Phylogenetic relationships of epacrids and vaccinioids (Ericaceae s. l.) based on matK sequence data. *Plant Systematics and Evolution* 218: 55–65.
- Kubkova J. 1967. Contribution to the classification of root systems of woody plants. *Preslia* 39: 236–243.
- Kubota M, McGonigle TP, Hyakumachi M. 2001. *Clethra barbinervis*, a member of the Ericales, forms arbuscular mycorrhizae. *Canadian Journal of Botany* 79: 300–306.
- Kuzoff RK, Gasser CS. 2000. Recent progress in reconstructing angiosperm phylogeny. *Trends in Plant Science* 5: 330–336.
- Lamont B. 1982. Mechanisms for enhancing nutrient uptake in plants, with particular reference to mediterranean South Africa and Western Australia. *The Botanical Review* 48: 597–689.
- Landerweert R, Hoffland E, Finlay RD, Kuyper TW, van Breemen N. 2001. Linking plants to rocks: ectomycorrhizal fungi mobilize nutrients from minerals. *Trends in Ecology and Evolution* 16: 248–254.
- Lapeyrie FF, Chilvers GA. 1985. An endomycorrhiza–ectomycorrhiza succession associated with enhanced growth of *Eucalyptus dumosa* seedlings planted in a calcareous soil. *New Phytologist* 100: 93–104.
- Leake JL. 1994. The biology of myco-heterotrophic ('saprophytic') plants. *New Phytologist* 127: 171–216.
- LePage BA, Currah RS, Stockey RA, Rothwell GW. 1997. Fossil ectomycorrhizae from the Middle Eocene. *American Journal of Botany* 84: 410–412.
- Lesica P, Antibus RK. 1986. Mycorrhizal status of hemiparasitic vascular plants in Montana USA. *Transactions of the British Mycological Society* 86: 341–343.
- Ligrone R. 1988. Ultrastructure of a fungal endophyte in *Phaeoceros laevis* (L.) Prosk. (Anthocerotophyta). *Botanical Gazette* 149: 92–100.
- Ligrone R, Lopes C. 1989. Cytology and development of a mycorrhiza-like infection in the gametophyte of *Conocephalum conicum* (L.) Dum. (Marchantiales, Hepatophyta). *New Phytologist* 111: 423–433.
- Lindahl B, Stenlid J, Olsson S, Finlay R. 1999. Translocation of ^{32}P between interacting mycelia of a wood-decomposing fungus and ectomycorrhizal fungi in microcosm systems. *New Phytologist* 144: 183–193.

- Ling-Lee M, Chilvers GA, Ashford AE. 1977. A histochemical study of phenolic materials in mycorrhizal and uninfected roots of *Eucalyptus fastigata* Deand and Maiden. *New Phytologist* 78: 313–328.
- LoBuglio KF, Berbee ML, Taylor JW. 1996. Phylogenetic origins of the asexual mycorrhizal symbiont *Cenococcium geophilum* Fr. and other mycorrhizal fungi among Ascomycetes. *Molecular Phylogenetics and Evolution* 6: 287–294.
- Lodge DJ. 2000. Ecto- or arbuscular mycorrhizas – which are best? (Forum). *New Phytologist* 146: 353–354.
- Lodge DJ, Wentworth TR. 1990. Negative associations among VA-mycorrhizal fungi and some ectomycorrhizal fungi inhabiting the same root system. *Oikos* 57: 347–356.
- Lovera M, Cuenca G. 1996. Arbuscular mycorrhizal infection in Cyperaceae and Gramineae from natural, disturbed and restored savannas in La Gran Sabana, Venezuela. *Mycorrhiza* 6: 111–118.
- Lu XH, Malajczuk N, Brundrett M, Dell B. 1999. Fruiting of putative ectomycorrhizal fungi under blue gum (*Eucalyptus globulus*) plantations of different ages in Western Australia. *Mycorrhiza* 8: 255–261.
- Lyr H, Hoffmann G. 1967. Growth rates and growth periodicity of tree roots. *International Review of Forestry Research* 2: 181–236.
- Manjunath A, Habte M. 1991. Root morphological characteristics of host species having distinct mycorrhizal dependency. *Canadian Journal of Botany* 69: 671–676.
- Marchner H. 1995. *Mineral nutrition of higher plants*. London, UK: Academic Press.
- Massicotte HB, Ackerley CA, Peterson RL. 1987. The root–fungus interface as a indicator of symbiont interaction in ectomycorrhizae. *Canadian Journal of Forestry Research* 17: 846–854.
- Massicotte HB, Melville LH, Peterson RL, Luoma DL. 1998. Anatomical aspects of field ectomycorrhizas on *Polygonum viviparum* (Polygonaceae) and *Kobresia bellardii* (Cyperaceae). *Mycorrhiza* 7: 287–292.
- Massicotte HB, Molina R, Tackaberry Smith JE, Amaranthus MP. 1999. Diversity and host specificity of ectomycorrhizal fungi retrieved from three adjacent forest sites by five host species. *Canadian Journal of Botany* 77: 1053–1067.
- Massicotte HB, Peterson RL, Melville LH. 1989. Hartig net structure of ectomycorrhizae synthesised between *Laccaria bicolor* (Tricholomataceae) and two hosts: *Betula alleghaniensis* (Betulaceae) and *Pinus resinosa* (Pinaceae). *American Journal of Botany* 76: 1654–1667.
- Matsubara Y-I, Uetake Y, Peterson RL. 1999. Entry and colonisation of *Asparagus officinalis* roots by arbuscular mycorrhizal fungi with emphasis on changes in host microtubules. *Canadian Journal of Botany* 77: 1159–1167.
- McGee PA. 1985. Lack of spread of endomycorrhizas of *Centaureium* (Gentianaceae). *New Phytologist* 101: 451–458.
- McGee PA. 1988a. Growth response to and morphology of mycorrhizas of *Thysanotus* (Anthericaceae: Monocotyledonae). *New Phytologist* 109: 459–463.
- McGee PA. 1988b. Vesicular–arbuscular and ectomycorrhizas on the annual composite, *Podotheca angustifolia*. *Symbiosis* 6: 271–280.
- McGee PA, Bullock S, Summerell BA. 1999. Structure of mycorrhizae of the Wollemi Pine (*Wollemia nobilis*) and related Araucariaceae. *Australian Journal of Botany* 47: 85–95.
- McKendrick SL. 1996. The effects of shade on seedlings of *Orchis morio* and *Dactylorhiza fuchsii* in chalk and clay soil. *New Phytologist* 134: 343–352.
- McKendrick SL, Leake JR, Taylor DL, Read DJ. 2000. Symbiotic germination and development of myco-heterotrophic plants in nature: ontogeny of *Corallorhiza trifida* and characterization of its mycorrhizal fungi. *New Phytologist* 145: 523–537.
- McLaughlin MJ. 1996. Phosphorus in Australian forest soils. In: Ariswell PM, Adams MA, eds. *Nutrition of eucalypts*. Collingwood, Australia: CSIRO Publishing, 1–30.
- McLean CB, Cunningham JH, Lawrie AC. 1999. Molecular diversity within and between ericoid endophytes from the Ericaceae and Epacridaceae. *New Phytologist* 144: 351–358.
- McLennan E. 1958. *Thismia rodwayi* F. Muell. and its endophyte. *Australian Journal of Botany* 6: 25–37.
- Melville LH, Massicotte HB, Peterson RL. 1987. Ontogeny of early stages of ectomycorrhizae synthesised between *Dryas integrifolia* and *Hebeloma cylindrosporum*. *Botanical Gazette* 148: 332–341.
- Meney KA, Dixon KW, Scheltema M, Pate JS. 1993. Occurrence of vesicular mycorrhizal fungi in dryland species of Restionaceae and Cyperaceae from south-west Western Australia. *Australian Journal of Botany* 41: 733–737.
- Merryweather J, Fitter A. 1998. The arbuscular mycorrhizal fungi of *Hyacinthoides non-scripta*. I. Diversity of fungal taxa. *New Phytologist* 138: 117–129.
- Miles RM, Smith CR, Jastrow JD, Bever JD. 1999. Mycorrhizal status of the genus *Carex* (Cyperaceae). *American Journal of Botany* 86: 547–553.
- Molina R, Massicotte H, Trappe JM. 1992. Specificity phenomena in mycorrhizal symbiosis: community-ecological consequences and practical implications. In: Allen MF, ed. *Mycorrhizal functioning*. London, UK: Chapman & Hall, 357–423.
- Molvray M, Kores PJ, Chase MW. 2000. Polyphyly of mycoheterotrophic orchids and functional influences on floral and molecular characteristics. In: Wilson KL, Mossion DA, eds. *Monocots: systematics and evolution*. Melbourne, Australia: CSIRO, 441–448.
- Moncalvo J-M, Lutzoni FM, Rehner SA, Johnson J, Vilgalys R. 2000. Phylogenetic relationships of agaric fungi based on nuclear large subunit ribosomal DNA sequences. *Systematic Biology* 49: 278–305.
- Monreal M, Berch SM, Berbee M. 1999. Molecular diversity of ericoid mycorrhizal fungi. *Canadian Journal of Botany* 77: 1580–1594.
- Mora CI, Driese SG, Colarusso LA. 1996. Middle to Late Paleozoic CO₂ levels from soil carbonate and organic matter. *Science* 271: 1105–1107.
- Morton JB. 1990. Evolutionary relationships among arbuscular mycorrhizal fungi in the Endogonaceae. *Mycologia* 82: 192–207.
- Morton JB, Redecker D. 2001. Two new families of Glomales, Archaeosporaceae and Paraglomaceae, with two new genera *Archaeospora* and *Paraglomus*, based on concordant molecular and morphological characters. *Mycologia* 93: 181–195.
- Mosse B. 1973. Plant growth responses to vesicular-arbuscular mycorrhiza. IV. In soil given additional phosphorus. *New Phytologist* 72: 127–136.
- Moyersoen B, Fitter AH. 1998. Presence of arbuscular mycorrhizas in typically ectomycorrhizal host species from Cameroon and New Zealand. *Mycorrhiza* 8: 247–253.
- Moyersoen B, Fitter AH, Alexander IJ. 1998. Spatial distribution of ectomycorrhizas and arbuscular mycorrhizas in Korup National Park rain forest, Cameroon, in relation to edaphic parameters. *New Phytologist* 139: 311–320.
- Müller J, Dullieu H. 1998. Enhanced growth on non-photosynthesizing tobacco mutants in the presence of a mycorrhizal inoculum. *Journal of Experimental Botany* 49: 707–711.
- Newbery DM, Alexander IJ, Rother JA. 1997. Phosphorus dynamics in a lowland African rain forest: the influence of ectomycorrhizal trees. *Ecological Monographs* 67: 367–409.
- Newman EI, Reddell P. 1987. The distribution of mycorrhizas among families of vascular plants. *New Phytologist* 106: 745–751.
- Newsham KK, Fitter AH, Watkinson AR. 1995. Arbuscular mycorrhiza protect an annual grass from root pathogenic fungi in the field. *Journal of Ecology* 83: 991–1000.
- Newton AC. 1991. Mineral nutrition and mycorrhizal infection of seedling oak and birch III. Epidemiology aspects of ectomycorrhizal infection, and the relationship with seedling growth. *New Phytologist* 117: 53–60.
- Nixon KC, Crepet WL. 1993. Late Cretaceous fossil flowers of ericoid affinity. *American Journal of Botany* 80: 616–623.
- Noelle W. 1910. Studien zur vergleichenden anatomie und morphologie der koniferenwurzeln mit rücksicht auf die systematik. *Botanische Zeitung* 68: 169–266.

- Nylund J-E. 1987. The ectomycorrhizal infection zone and its relation the acid polysaccharides of cortical cell walls. *New Phytologist* 106: 505–516.
- Olson PA. 1999. Signature fatty acids provide tools for determination of the distribution and interactions of mycorrhizal fungi in soil. *FEMS Microbiology Ecology* 29: 303–310.
- Paris F, Bonnaud P, Ranger J, Lapeyrie F. 1995. In vitro weathering of phlogopite by ectomycorrhizal fungi. I. Effect of K⁺ and Mg²⁺ deficiency on phyllosilicate evolution. *Plant and Soil* 177: 191–201.
- Pemberton LMS, Tsai SL, Lovell PH, Harris PJ. 2001. Epidermal patterning in seedling roots of eudicotyledons. *Annals of Botany* 87: 649–645.
- Perumalla CJ, Peterson CA, Enstone DE. 1990. A survey of angiosperm species to detect hypodermal Casparian bands. I. Roots with a uniseriate hypodermis and epidermis. *Botanical Journal of the Linnean Society* 103: 93–112.
- Peterson CA. 1988. Exodermal Casparian bands: their significance for ion uptake by roots. *Physiologia Plantarum* 72: 204–208.
- Peterson RL, Howarth MJ, Whittier DP. 1981. Interactions between a fungal endophyte and gametophyte cells in *Psilotum nudum*. *Canadian Journal of Botany* 59: 711–720.
- Phipps CJ, Taylor TN. 1996. Mixed arbuscular mycorrhizae from the Triassic of Antarctica. *Mycologia* 88: 707–714.
- Pirozynski KA, Dalpé Y. 1989. Geological history of the Glomaceae with particular reference to mycorrhizal symbiosis. *Symbiosis* 7: 1–36.
- Ponge JF. 1991. Succession of fungi and fauna during decomposition of needles in a small area of Scots pine litter. *Plant and Soil* 138: 99–113.
- Pope EJ, Carter DE. 2001. Phylogenetic placement and host specificity of mycorrhizal isolates belonging to AG-6 and AG-12 in the *Rhizoctonia solani* species complex. *Mycologia* 93: 712–719.
- Pozo MJ, Azcón-Aguiler C, Dumas-Goaudot E, Barea JM. 1998. Chitosanase and chitinase activities in tomato roots during interactions with arbuscular mycorrhizal fungi or *Phytophthora parasitica*. *Journal of Experimental Botany* 49: 1729–1739.
- Pringle A, Moncalve J-M, Vilgalys R. 2000. High levels of variation in ribosomal DNA sequences within and among spores of a natural population of the arbuscular mycorrhizal fungus *Acaulospora colossica*. *Mycologia* 92: 259–268.
- Pryer KM, Schneider H, Smith AR, Cranfill R, Wolf PG, Hunt JS, Sipes SD. 2001. Horsetails and ferns are a monophyletic group and the closest living relatives to seed plants. *Nature* 409: 618–622.
- Pirozynski KA, Malloch DW. 1975. The origin of land plants: a matter of mycotropism. *Biotropism* 6: 153–164.
- Rabatin SC. 1980. The occurrence of the vesicular-arbuscular mycorrhizal fungus *Glomus tenuis* with moss. *Mycologia* 72: 191–195.
- Ramsay RR, Dixon KW, Sivasithamparam K. 1986. Patterns of infection and endophytes associated with Western Australian orchids. *Lindleyana* 1: 203–214.
- Ramsay RR, Sivasithamparam K, Dixon KW. 1987. Anastomosis groups among rhizoctonia-like endophytic fungi in Southwestern Australian *Pterostylis* species (Orchidaceae). *Lindleyana* 2: 161–166.
- Rasmussen HN. 1995. *Terrestrial orchids from seed to mycotrophic plants*. Cambridge, UK: Cambridge University Press.
- Rasmussen FN. 2000. Ins and outs of orchid phylogeny. In: Wilson KL, Morrison DA, eds. *Monocots: systematics and evolution*. Melbourne, Australia: CSIRO, 430–435.
- Raven JA, Edwards D. 2001. Roots: evolutionary origins and biogeochemical significance. *Journal of Experimental Botany* 52: 381–401.
- Read DJ, Duckett JG, Francis R, Ligrone R, Russell A. 2000. Symbiotic fungal associations in lower land plants. *Philosophical Transactions of the Royal Society of London Series B* 355: 815–831.
- Redecker D, Kodner R, Graham JE. 2000a. Glomalean fungi from the Ordovician. *Science* 289: 1920–1921.
- Redecker D, Morton JB, Bruns TD. 2000b. Ancestral lineages of arbuscular mycorrhizal fungi (Glomales). *Molecular Phylogenetics and Evolution* 14: 276–284.
- Reinsvold RJ, Reeves FB. 1986. The Mycorrhizae of *Juniperus osteosperma*: identity of the vesicular-arbuscular mycorrhizal symbiont, and resynthesis of VA mycorrhizae. *Mycologia* 78: 108–113.
- Renzaglia KS, Duff RJ, Nickrent DL, Garbary DJ. 2000. Vegetative and reproductive innovations of early land plants: implications for a unified phylogeny. *Philosophical Transactions of the Royal Society of London B* 355: 769–793.
- Rothwell GW. 1996. Pteridophyte evolution: an often under-appreciated phylogenetic success story. *Review of Paleobotany and Palynology* 90: 209–222.
- Russell RS. 1977. *Plant root systems: their function and interaction with the soil*. London, UK: McGraw-Hill Book Co, Ltd.
- Saikkonen K, Faeth SH, Helander M, Sullivan TJ. 1998. Fungal endophytes: a continuum of interactions with host plants. *Annual Review of Ecology and Systematics* 29: 319–343.
- Salmia A. 1988. Endomycorrhizal fungus in chlorophyll-free and green forms of the terrestrial orchid *Epipactis helleborine*. *Karsenia* 28: 3–18.
- Schmid E, Oberwinkler F. 1993. Mycorrhiza-like interaction between the achlorophyllous gametophyte of *Lycopodium clavatum* L. & its fungal endophyte studied by light and electron microscopy. *New Phytologist* 124: 69–81.
- Schmid E, Oberwinkler F. 1994. Light and electron-microscopy of the host-fungus interaction in the achlorophyllous gametophyte of *Botrychium lunaria*. *Canadian Journal of Botany* 72: 182–188.
- Schmid E, Oberwinkler F. 1995. A light and electron-microscope study on a vesicular-arbuscular host-fungus interaction in gametophytes and young sporophytes of the Gleicheniaceae (Filicales). *New Phytologist* 129: 317–324.
- Schüßler A. 2000. *Glomus claroideum* forms and arbuscular mycorrhiza-like symbiosis with the hornwort *Anthoceros punctatus*. *Mycorrhiza* 10: 15–21.
- Schüßler A, Gehrig H, Schwarzott D, Walker C. 2001. Analysis of partial Glomales SSU rRNA gene sequences: implications for primer design and phylogeny. *Mycological Research* 105: 5–15.
- Schüßler A, Kluge M. 2000. *Geosiphon pyriforme*, an endocytosymbiosis between fungus and cyanobacteria, and its meaning as a model system for Arbuscular mycorrhizal research. In: Hock B, ed. *The mycota IX fungal associations*. Berlin, Germany: Springer Verlag, 151–161.
- Schwab SM. 1982. Influence of simazine on formation of vesicular-arbuscular mycorrhizae in *Chenopodium quinona* Willd. *Plant and Soil* 64: 283–287.
- Schwartz MW, Hoeksema JD. 1998. Specialization and resource trade: Biological markers as a model of mutualisms. *Ecology* 79: 1029–1038.
- Schweiger PF, Robson AD, Barrow NJ. 1995. Root hair length determines beneficial effect of a *Glomus* species on shoot growth of some pasture species. *New Phytologist* 131: 247–254.
- Sculthorpe CD. 1967. *The biology of aquatic vascular plants*. London UK: Edward Arnold Ltd.
- Sen R, Hietala AM, Zelmer C. 1999. Common anastomosis and internal transcribed spacer RFLP groupings in binucleate *Rhizoctonia* isolates representing root endophytes of *Pinus sylvestris*, *Ceratophylla* spp. from orchid mycorrhizas and a phytopathogenic anastomosis group. *New Phytologist* 144: 331–341.
- Sharples JM, Chambers SM, Meharg AA, Cairney JW. 2000. Genetic diversity of root-associated fungal endophytes from *Calluna vulgaris* at contrasting field sites. *New Phytologist* 148: 153–162.
- Shinohara ML, LoBuglio KF, Rogers SO. 1999. Comparison of ribosomal DNA ITS regions among geographic isolates of *Cenococcum geophilum*. *Current Genetics* 35: 527–535.
- Shishkoff N. 1987. Distribution of the dimorphic hypodermis of roots in Angiosperm families. *Annals of Botany* 60: 1–15.
- Simon L, Bousquet J, Lévesque C, Lalonde M. 1993. Origin and diversification of endomycorrhizal fungi and coincidence with vascular land plants. *Nature* 363: 67–69.

- Skene KR. 1998. Cluster roots: some ecological considerations. *Journal of Ecology* 86: 1060–1064.
- Smith SE, Dickson S, Walker NA. 1992. Distribution of VA mycorrhizal entry points near the root apex: Is there an infectable zone at the root tip of leek of clover? *New Phytologist* 89: 403–407.
- Smith SE, Read DJ. 1997. *Mycorrhizal symbiosis*. London, UK: Academic Press.
- Smith SE, Smith FA. 1990. Structure and function of the interfaces in biotrophic symbioses as they relate to nutrient transfer. *New Phytologist* 114: 1–38.
- Smith FA, Smith SE. 1997. Structural diversity in (vesicular)–arbuscular mycorrhizal symbioses. *New Phytologist* 137: 373–388.
- Soltis DE, Soltis PS, Chase MW, Mort ME, Albach DC, Zanis M, Savolainen V, Hahn WH, Hoot SB, Fay MF, Axtell M, Swensen SM, Prince LM, Kress WJ, Nixon KC, Farris JS. 2000. Angiosperm phylogeny inferred from 18S rDNA, rbcL, and atpB sequences. *Botanical Journal of the Linnean Society* 133: 381–461.
- St John TV. 1980. A survey of mycorrhizal infection in an Amazonian rain forest. *Acta Amazonica* 10: 527–533.
- St John TV, Coleman DC, Reid CPP. 1983. Growth and spatial distribution of nutrient-absorbing organs: selective exploitation of soil heterogeneity. *Plants and Soil* 71: 487–493.
- Stahl M. 1949. Die Mykorrhiza der Lebermoose mit besonderer Berücksichtigung der thalloiden Formen. *Planta* 37: 103–148.
- Stern WL, Warcup JH. 1994. Root tubercles of apostasiad orchids. *American Journal of Botany* 81: 1671–1575.
- Stewart WN, Rothwell GW. 1993. *Paleobotany and the evolution of plants*. Cambridge, UK: Cambridge University Press.
- Stubblefield SP, Taylor TN. 1988. Recent advances in paleomycology. *New Phytologist* 108: 3–25.
- Tagu D, De Bellis R, Balestrini R, De Vries OMH, Piccoli G, Stocchi V, Bonfante P, Martin F. 2001. Immunolocalization of hydrophobin HYDPt-1 from the ectomycorrhizal basidiomycete *Pisolithus tinctorius* during colonization of *Eucalyptus globulus* roots. *New Phytologist* 149: 127–135.
- Taylor DL, Bruns TD. 1999. Population, habitat and genetic correlates of mycorrhizal specialization in the 'cheating' orchids *Corallorhiza maculata* and *C. mertensiana*. *Molecular Ecology* 8: 1719–1732.
- Taylor TN, Hass H, Kerp H. 1997. A cyanolichen from the Lower Devonian Rhynie chert. *American Journal of Botany* 84: 992–1004.
- Taylor TN, Osborn JM. 1996. The importance of fungi in shaping the paleoecosystem. *Review of Paleobotany and Palynology* 90: 249–262.
- Taylor TN, Remy W, Hass H, Kerp H. 1995. Fossil arbuscular mycorrhizae from the early Devonian. *Mycologia* 87: 560–573.
- Taylor TN, Taylor EL. 1993. *The biology and evolution of fossil plants*. Englewood Cliffs, NJ, USA: Prentice Hall.
- Taylor TN, Taylor EL. 1997. The distribution and interactions of some Paleozoic fungi. *Review of Paleobotany and Palynology* 95: 83–94.
- Tehler A, Farris JS, Lipscomb DL, Källersjö M. 2000. Phylogenetic analyses of the fungi based on large rDNA data sets. *Mycologia* 92: 459–474.
- Terashita T, Chuman S. 1987. Fungi inhabiting wild orchids in Japan (IV). *Armiliariella tabescens*, a new symbiont of *Galeola septentrionalis*. *Transactions of the Mycological Society of Japan* 28: 145–154.
- Tester M, Smith SE, Smith FA. 1987. The phenomenon of nonmycorrhizal plants. *Canadian Journal of Botany* 65: 419–431.
- Tisserant B, Gianinazzi S, Gianinazzi-Pearson V. 1996. Relationship between lateral root order, arbuscular mycorrhiza development, and the physiological state of the symbiotic fungus in *Platanus acerifolia*. *Canadian Journal of Botany* 74: 1947–1955.
- Tommerup IC. 1984. Development of infection by a vesicular–arbuscular mycorrhizal fungus in *Brassica napus* L. and *Trifolium subterraneum* L. *New Phytologist* 98: 487–495.
- Trappe JM. 1965. Tuberculate mycorrhizae of douglas-fir. *Forest Science* 11: 27–32.
- Trappe JM. 1987. Phylogenetic and ecologic aspects of mycotrophy in the angiosperms from an evolutionary standpoint. In: Safir GR, ed. *Ecophysiology of va mycorrhizal plants*. Boca Raton, FL, USA: CRC Press, 5–25.
- Turnau K, Roniker M, Unrung J. 1999. Role of mycorrhizal links between plants in establishment of liverworts thalli in natural habitats. *Acta Societatis Botanicorum Poloniae* 68: 63–68.
- Turnbull MH, Goodall R, Stewart GR. 1995. The impact of mycorrhizal colonization upon nitrogen source utilization and metabolism in seedlings of *Eucalyptus grandis* Hill ex Maiden and *Eucalyptus maculata* Hook. *Plant, Cell & Environment* 18: 1386–1394.
- Umata H. 1998. A new biological function of shiitake mushroom, *Lentinula edodes*, in a myco-heterotrophic orchid, *Erythrorchis ochobiensis*. *Mycoscience* 39: 85–88.
- Umata H. 1999. Germination and growth of *Erythrorchis ochobiensis* (Orchidaceae) accelerated by monokaryons and dikaryons of *Lenzites betulinus* and *Trametes hirsuta*. *Mycoscience* 40: 367–371.
- Unrug J, Turnau K. 1999. Mycorrhiza of *Dryopteris carthusiana* in southern Poland. *Acta Mycologica* 34: 305–314.
- Vesk PA, Ashford AE, Markovina A-L, Allaway WG. 2000. Apoplasmic barriers and their significance in the exodermis and sheath of *Eucalyptus pilularis*-*Pisolithus tinctorius* ectomycorrhizas. *New Phytologist* 145: 333–346.
- Vierheilig H, Bennett R, Kiddle G, Kaldorf M, Ludwig-Müller J. 2000. Differences in glucosinolate patterns and arbuscular mycorrhizal status of glucosinolate-containing plant species. *New Phytologist* 146: 343–352.
- Vrålstad T, Fosshelm T, Schumacher T. 2000. *Piccirhiza bicolorata* – the ectomycorrhizal expression of the *Hymenoscyphus ericae* aggregate? *New Phytologist* 145: 549–563.
- Wang DYC, Kumar S, Hedges SB. 1999. Divergence time estimates for the early history of animal phyla and the origin of plants, animals and fungi. *Proceedings of the Royal Society of London B* 266: 163–171.
- Warcup JH. 1980. Ectomycorrhizal associations of Australian indigenous plants. *New Phytologist* 85: 531–535.
- Warcup JH. 1981. Mycorrhizal relationships of Australian orchids. *New Phytologist* 87: 371–381.
- Warcup JH. 1988. Mycorrhizal associations and seedlings development in Australian Lobeliaceae (Campanulaceae). *Australian Journal of Botany* 36: 461–472.
- Wegel E, Schauser L, Sandal N, Stougaard J, Parnishe M. 1998. Mycorrhiza mutants of *Lotus japonicus* define genetically independent steps during symbiotic infection. *Molecular Plant–Microbe Interactions* 9: 933–936.
- Wilcox HE. 1964. Xylem in roots of *Pinus resinosa* Ait. in relation to heterorhizy and growth activity. In: Zimmerman MH, ed. *The formation of wood in forest trees*. New York, USA: Academic Press, 459–478.
- Wilkinson DM. 1997. The role of seed dispersal in the evolution of mycorrhizae. *Oikos* 78: 394–396.
- Wilson D. 1993. Fungal endophytes: out of sight but should not be out of mind. *Oikos* 68: 373–384.
- Wing SL, Boucher LD. 1998. Ecological aspects of the Cretaceous flowering plant radiation. *Annual Review of Earth and Planet Science* 26: 379–421.
- Wu Q-X, Mueller GM, Lutzoni FM, Huang Y-Q, Guo S-Y. 2000. Phylogenetic and biogeographic relationships of eastern Asian and eastern North American disjunct *Suillus* species (Fungi) as inferred from nuclear ribosomal RNA ITS sequences. *Molecular Phylogenetics and Evolution* 17: 37–47.
- Zhao ZW. 2000. The arbuscular mycorrhizas of pteridophytes in Yunnan, southwestern China: evolutionary interpretations. *Mycorrhiza* 10: 145–149.